



To our Customers:

Thank you for the opportunity to provide electric service to your project. To make the process run as effectively as possible for all concerned, we would like to identify for you some key elements that result in delays.

Customer Data Sheet

The information you provide on this form is critical to the initiation of any engineering work by TNMP. Some of the information required on this form may have to come from an electrician or engineer employed by you for your project. Regardless, the information must be complete and accurate. Any modifications or additions to the information after it is submitted can and usually do result in TNMP design delays. Your signature or the signature of your legal representative must be on the form. You are responsible for the information contained in the form.

Additional Data requirements

Depending on the project size, TNMP may require additional data to determine the facilities we need to install to serve you. After review of your initial document submittal, a Designer or Engineer will contact you to discuss the need for additional data. If you receive a request for additional data, the timelier you can provide the information, the better.

Easements & Permits

If TNMP installs distribution facilities across your property or any facilities across the property of another to provide service, an easement must be granted. If TNMP must cross a state highway, farm market road or railroad, permits from the state or railroad owner are required. TNMP will discuss with you the process of providing an easement if it is required for your project. A project will not be released to the Operations group for construction until all required easements and/or permits are in place.

Multiple Designs

TNMP tariffs allow for one design to be provided to the customer as a part of the original request for service. This design is based on the information provided by the customer when

the Customer Data Sheet is submitted. Should the customer reject the design and want alternatives prepared, the labor costs associated with the additional design work is subject to collection from the customer. Requests for additional designs will result in project delays.

TNMP is required to collect the cost of improvements that cannot be justified by the revenue received from the continuing electric service to the project. For residential service, the customer receives a maximum \$3,000 of credit toward the cost of construction. For small commercial service up to a demand of 9KW, the maximum credit is \$3,000. For larger commercial projects, a credit of \$182.00 per KW is provided.

Any costs incurred to install TNMP facilities in excess of the allowed credit is payable by the customer before any material is ordered for the project. The invoice you receive has a notice that costs may change after 60 days. If TNMP does not receive payment by that time, the current invoice will be voided, and a new invoice generated reflecting the prevailing market prices.

Failure to pay the invoice in a timely manner will delay the project.

Material Lead Times

If your project requires material not normally stocked in the distributors warehouse, your project may be subject to delays for material ordering and receipt. Depending on the materials required for your project; those delays could be as much as 26 weeks. A TNMP representative will inform you as early in the process as possible if your project might be subject to significant material lead time delays.

Please remember, no material is ordered until any required payments are made by the customer.

We hope the information provided here will help guide you in making the process of getting electric service as pleasant as possible.

Customer Data Sheet



Please complete all applicable sections and mail or fax the signed and completed form to your engineering designer

Customer Information:

Name: _____			
Mailing Address: _____			
City, State, Zip: _____			
Telephones: Home: _____	Work: _____	Cell: _____	E-Mail: _____

Easement Information:

An easement is required for these facilities: <u>YES</u> <u>NO</u> <i>(Designer - please circle YES or NO)</i>			
<i>If an easement is required please provide the following information:</i>			
Landowner Name(s): _____			
Address <i>(if different from above)</i> : _____			
County Name: _____	Number of Acres: _____	Abstract/Survey: _____	
Deed Recorded in Volume: _____	Page Number: _____		

Other Contacts:

Builder/General Contractor: _____	Phone: _____
Electrician/Electrical Contractor: _____	Phone: _____
Architect/Consulting Engineer: _____	Phone: _____

Electrical Load Information: *(please have your electrician provide this information)*

Load Type <i>(circle one)</i> <u>Residential</u> <u>Commercial</u>	Service Type <i>(circle one)</i> : <u>Overhead</u> <u>Underground</u>		
Service Voltage <i>(check one)</i> :	Service Capacity: <i>(check one.)</i>	Conduit Information:	
_____ 120/240 Volt, 3-wire single-phase	_____ 100 Amp	Number: _____	
_____ 120/240 Volt, 4-wire three-phase Delta	_____ 200 Amp	Size: _____	
_____ 120/208 Volt, 4-wire three-phase Wye	_____ 320 Amp		
_____ 277/480 Volt, 4-wire three-phase Wye	_____ 600 Amp Transocket		
_____ Other <i>(specify)</i> :	_____ Other <i>(specify)</i> :		
Load Data:		Living Sq. Ft.: _____	
_____ Electric Heat	Phase: _____ Voltage: _____	Amps: _____	Size: _____ (kW)
_____ Air Conditioning	Phase: _____ Voltage: _____	Amps: _____	Size: _____ (Tons)
_____ Electric Cooking	Phase: _____ Voltage: _____	Amps: _____	Size: _____ (kW)
_____ Lighting Load	Phase: _____ Voltage: _____	Amps: _____	Size: _____ (kW)
_____ Motor Load(s)	Phase: _____ Voltage: _____	Amps: _____	Size: _____ (HP)
Electrician Name: _____		Electrician Phone: _____	

Customer Signature: _____
 Date Signed: _____

Please mail or fax this signed form to your engineering designer!

Thank You!

Texas New Mexico Power

North Texas Region.....972-317-5542 ext. 4016

.....972-317-5542 ext. 4018

Lewisville Region.....972-317-5542 ext. 4018

.....972-317-5542 ext. 4016

Central Texas Region.....254-675-3908 ext. 6136

Gulf Coast Region-Bay Area.....281-996-0453 ext. 7121

.....281-996-0453 ext. 7122

Gulf Coast Region-Mainland.....409-948-8451 ext. 4261

Gulf Coast Region-Brazos.....979-345-4422 ext. 5133

West Texas Region.....432-447-2182 ext. 4923

.....432-447-2182 ext. 4922

.....432-447-2182 ext. 4906

Obtaining New Service



In order to proceed with new service installation, follow the following steps:

Step 1 – Meet with a TNMP representative to discuss electrical service requirements:

- Call TNMP to request a meeting with an engineering designer.
- The designer will inspect the desired location to determine what equipment is necessary to establish service.
- The designer will also discuss possible fees and charges associated with the new service. If applicable, the customer may be required to pay any contributions in aid of construction (CIAC).
- No work will be done or materials ordered until the CIAC has been paid.
- For underground service, ditching and installation of conduit will be done at customer's expense to TNMP specifications.
- TNMP must inspect the ditch and conduit installation prior to covering up the ditch.

Step 2 – Determine Load Information:

- Before the designer can begin the plans for new service, the designer must know the load information.
- The load information is an accurate record of the power requirements of the new service and can be compiled by an electrician.

Step 3 – Easement Information:

- TNMP may require an electric line easement from you before TNMP can install power poles on your property.
- If it is necessary to cross another landowner(s) property in order to deliver your service you will also have to secure an easement from each landowner.
- All easements must be completed before work can begin.

Step 4 – Landscaping Requirements:

- The customer is responsible for removing all trees, brush or limbs that obstruct access to construction. Refer to included drawing for a guideline.
- No construction work will occur until all obstacles have been removed.
- All limbs removed by TNMP will be left on site unless the customer requests limb removal which will be provided at an additional cost to the customer.

Step 5 – Meter Requirements:

- The customer is responsible for building the meter loop.
- The loop must be constructed in accordance with TNMP standards. **It is the customer's responsibility to call TNMP or an inspection after the meter loop is finished.**
- All inspection requirements apply to temporary meter poles as well as permanent installations.
- Please note that some cities require their own code enforcement inspections of meter loops. It is the responsibility of the customer to contact the city for such inspections.

Step 6 – Choosing a Retail Energy Provider:

- It is the responsibility of the customer to set up an account with a Retail Energy Provider.
- The State of Texas requires an Electric Service Identification Number (ESI ID#) for each meter location.
- After the meter loop passes inspection call TNMP to obtain an ESI ID#. You must have your ESI ID# when contacting your chosen REP.
- TNMP will send an energy technician to initiate service as soon as the REP issues a turn-on order.

Retail Energy Providers:
Phone: (866)797-4839
Website: www.powertochoose.org
(Note: Texas official contact REP site)



Frequently Asked Questions

1) How Long Does it Take to Get Power?

The amount of time varies, but in most cases the process will be completed in three to four weeks. You can help speed the process along by providing us with the information we need from you in as timely a manner as possible. The Customer Data Sheet (including easement information, if an easement is required for your electric line), complete with your signature plus the signed Letter of Permission are items that we have to get from you. Completing and signing these two forms and returning them to your engineering designer as soon as possible will help avoid delay in getting your power. Also note that if we require an easement we will need to receive the signed and notarized original document before we can build your power line.

2) What is a Contribution in Aid of Construction?

A Contribution in Aid of Construction, also known as CIAC, is a portion of the construction cost expense of building your power line that is borne by you. In calculating the CIAC charge we take into account the total cost to Texas-New Mexico Power Company of building your power line and the expected revenue generated by your electrical load. If the cost of building your line exceeds the revenue expected from the line this difference is treated as an unsupported investment and is borne by you. The exact amount of your CIAC charges will be quoted prior to any work being done.

3) What Other Fees May Apply?

The CIAC charges cover all the construction work of building your power line. The CIAC does not cover additional charges that may apply for temporary meter installations and removal and the installation of permanent service. If temporary service is required, a fee of \$240.00 will be added to the first month's bill.

4) What is an Easement?

An easement is a legal document granting the right to us to construct, maintain, and have access to our facilities (poles and wires) on private property. You, as property owner, grant the easement to us. You continue to own the land but are giving us the right to place our facilities there and to maintain them as time passes. In some cases, we may need to cross others' property to reach yours. If so, you may need to obtain an easement from adjoining landowner(s) as well.

We will request an easement for overhead lines and underground lines of a width that provides a safe distances from other structures and trees in order to comply with the National Electric Safety Code (NESC).

5) How Do I grant an Easement to Texas-New Mexico Power Company?

Your engineering designer will design an electric line to meet your needs and will inform you whether or not we require an easement from you. If we do require an easement you will need to provide us with a legal description of your property that includes the deed information as recorded in your County Clerk's office. Using this information we will prepare an "exhibit form" easement that references your property description and attaches a sketch as an exhibit describing the easement. You will then execute the easement by signing (all landowners must sign) and having the signatures notarized. We must receive the signed and notarized original (no copies) prior to constructing your electric line.

6) What if My Meter Loop Fails to Pass Inspection?

If your meter loop does not meet our standards upon inspection, our Energy Technician will place a red tag on it and leave a description of the defect(s) found. If you have any questions about the defects call us. After the defects are corrected we need to re-inspect the meter loop. Please call us to request the re-inspection.

7) Why Do I Need a Retail Energy Provider (REP)?

Texas-New Mexico Power Company does not provide retail electric service. Under Public Utility Commission of Texas rules, we are a Transmission and Distribution company – our role is to build and maintain your electric lines as reliably as possible. Under this arrangement, we work with you to get the facilities built to suit your needs. You will then have the right to choose your retail provider from all REP's authorized to do business in the State of Texas. The current list of authorized REP's is available online at www.powertochoose.org or you may call 1-866-797-4839

Specifications for Commercial Use



Service Entrance Conductors

The service entrance conductors shall be a minimum of 4/0 aluminum or 2/0 copper. Entrance conductors shall be installed in approved rigid metallic or non-metallic conduit or approved raceway. Approved service entrance cable may be used in lieu of conduit or raceway (subject to local code approval). The connection to the meter socket base shall be watertight and the service entrance shall be installed on the exterior of the building. In no instance shall service entrance conductors be run through attics, partitions or other enclosed places. No unsealable type fittings shall be installed in conduit or raceway ahead of the meter socket or metering enclosure.

Meter Location

Meter locations must have prior approval of Texas-New Mexico Power Company (TNMP). Meters shall be located so they are readily accessible by TNMP personnel and not exposed to physical or environmental dangers. Where meter socket or enclosure and disconnecting means are mounted adjacent to each other, they should be separated by at least four (4) inches. Socket or enclosure shall be mounted level with vertical plane of the building and securely mounted to the building. Meter loop must be either on the front of the building or on the side within 5 feet from the front corner. Location of meter socket must be approved by TNMP representative, and TNMP must have permanent access to meter socket.

Meter Socket or Enclosure Requirements

Meter sockets for service requirements less than 400 amps will be purchased and installed by the customer. They must be UL Listed and rated for a minimum of 200 amps. Underground service requires underground enclosures, not universal or modified overhead enclosures, with a dedicated raceway on the left side. Three-phase underground service requires enclosures rated 320 amps or greater. For service requirements in excess of 400 amps please contact your local TNMP representative.

Service Requirements in Excess of 200 Amps

In accordance with local authority, services should have a service disconnect device, accessible by TNMP personnel, located on the exterior wall of the building adjacent to the meter socket. TNMP recommends a disconnect device for all customers. A remote control device used to actuate the service disconnecting means may be located on the exterior of the building in lieu of the actual service disconnect. The remote control device must be accessible by TNMP personnel. TNMP personnel shall have the right to operate the disconnect device to remove load from TNMP equipment for any legitimate purpose including but not limited to: public safety concerns, compliance with TNMP personal safety procedures, and routine maintenance of TNMP equipment.

Energizing of Customer Service

Only authorized employees of TNMP are to make and energize the connections between the company's service wire and the customer's service entrance conductors.

Easement Requirements

- 1. Copy of the latest recorded Warranty Deed with File Number.**
- 2. Copy of Survey showing the needed Easement.**
- 3. Copy of Metes and Bounds (Schedule A) describing the needed Easement.**
- 4. Mark centerline of the needed Easement.**
- 5. Name of person (must be the deed holder) who will sign Easement, his / her title, state and county where he/she will sign the easement and a return address.**
- 6. If Grantor is a corporation, the state where it is incorporated.**
- 7. If Grantor is a partnership, the names of the other partners and the partnership.**

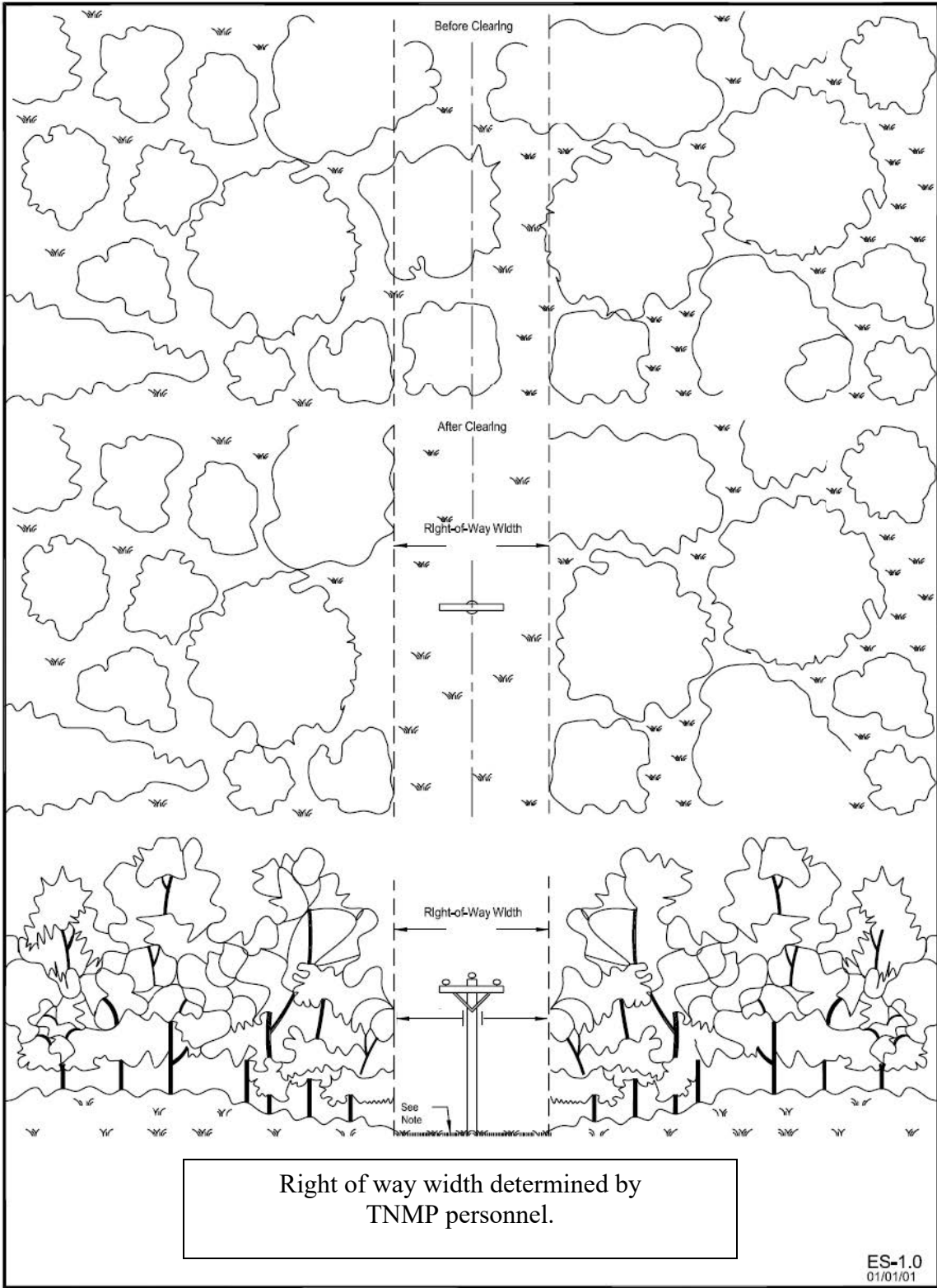

Right of way width determined by
TNMP personnel.

Right of way must be a minimum of 8 feet on both sides of underground cable and 16 feet to enclose the pad-mounted equipment.

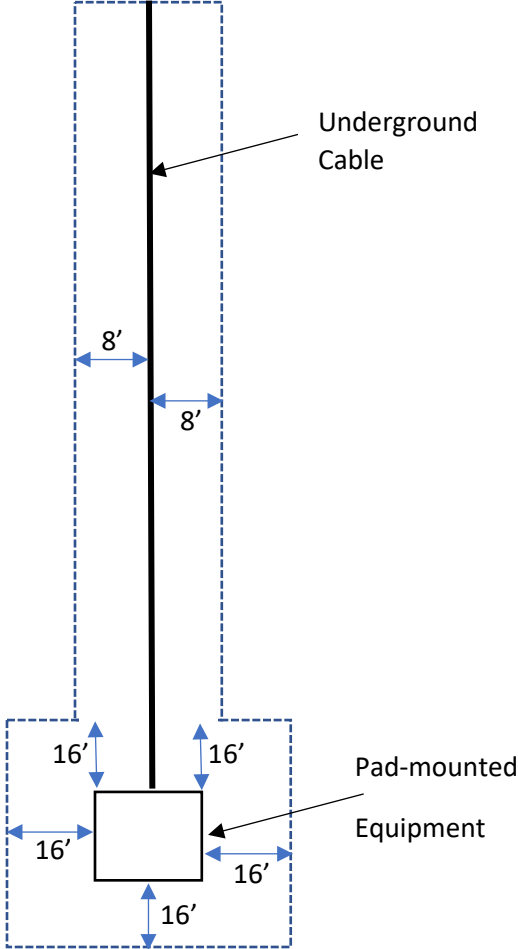

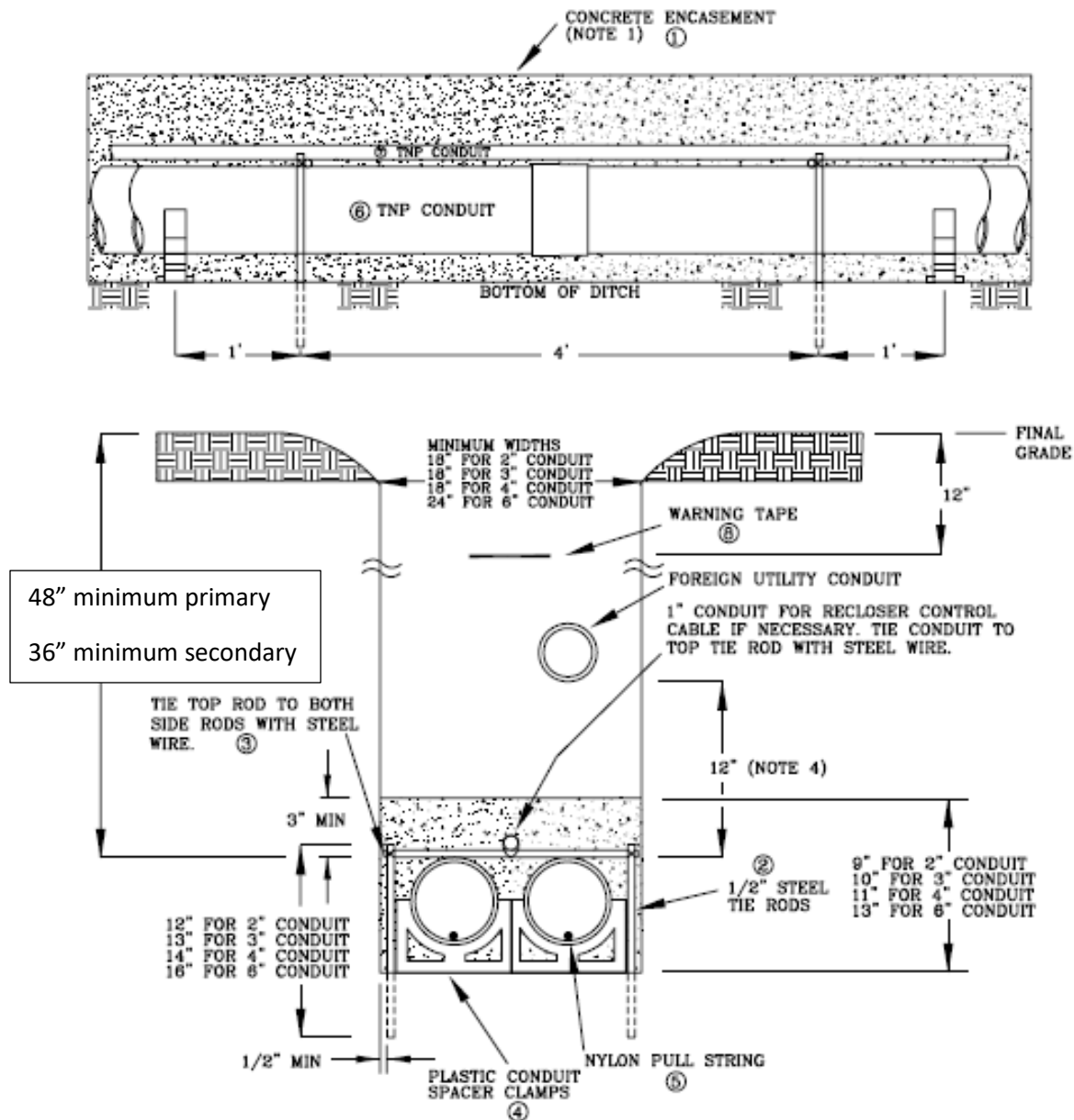

Notes:

1. Concrete to be 1:3:6 mix with no aggregate larger than 3/4". 3" minimum required around all conduits.
2. Tie rods shall be 1/2" steel.
3. All TNMP conduit shall be grey, schedule 40, or equivalent wall thickness, conventional PVC or Polyethylene continuous conduit.
4. Refer to UG-2-10 for exceptions.
5. TNMP shall size conduit.
6. TNMP representative shall inspect and approve conduit installation prior to concrete encasement.
7. Nylon pull string installed for pulling in TNMP pull wire.

48 in. Radius for Primary

36 in. Radius for Service

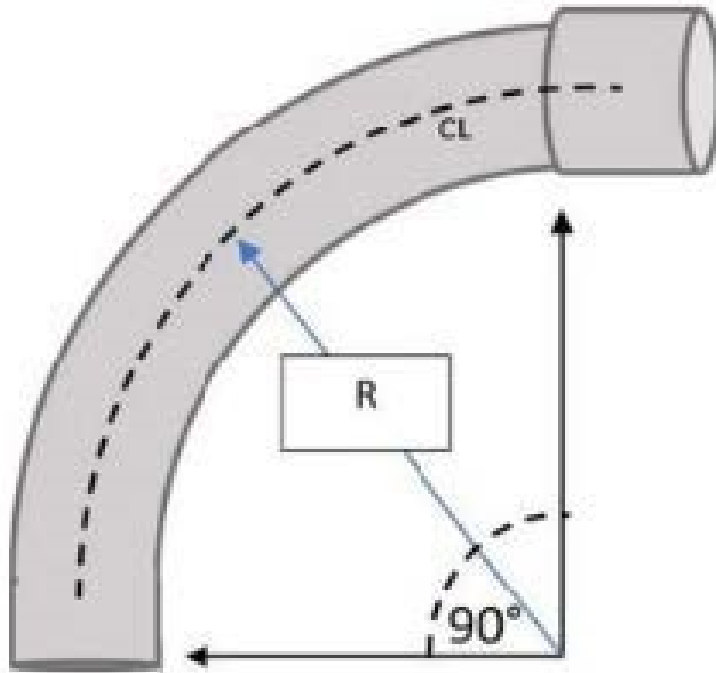

Drawing from todaypvcbending.com

Note: All conduit elbows require long sweeping 90's. For primary use a minimum of 48 inch and for service a 36 inch minimum radius is required.

REINFORCING NOT
LESS THAN 2" FROM
EDGES OF PAD

◦ GRD. SLEEVE
LOCATION

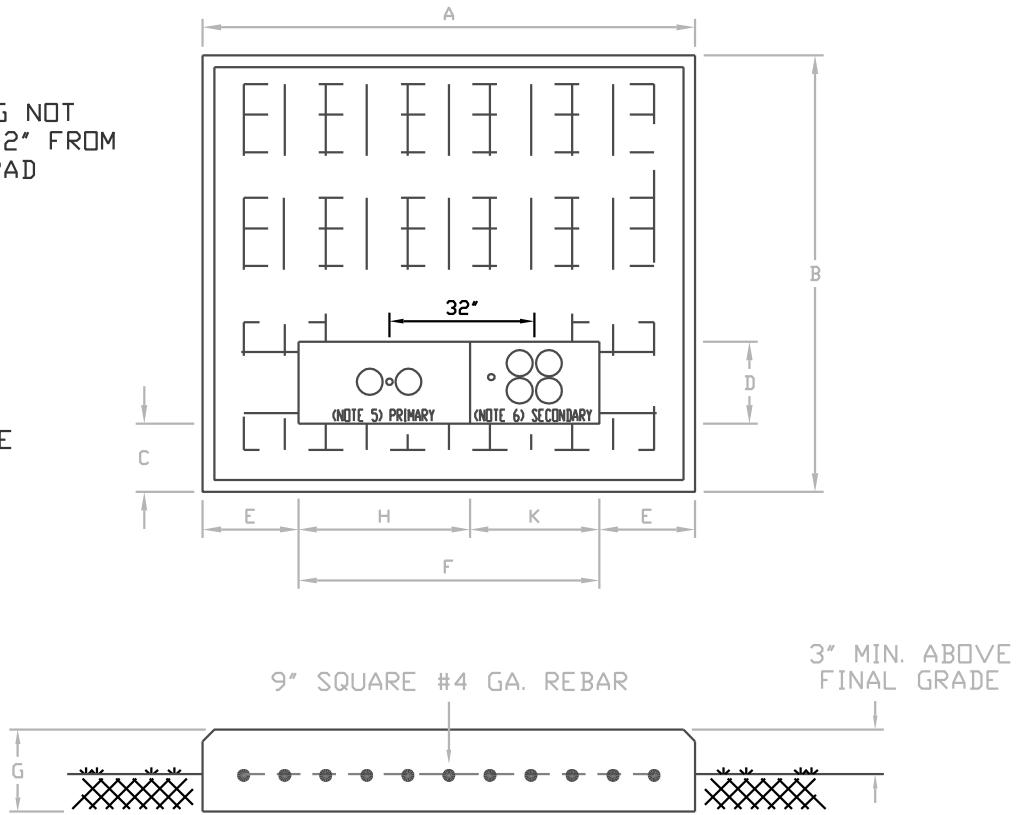

KVA	PAD DIMENSIONS IN INCHES									QUANTITIES	
	A	B	C	D	E	F	G	H	K	CONCRETE	REBAR
75 - 500	84	84	6	16	10	64	7	38	26	1.0	126
750 - 2500	84	108	10	16	10	64	7	38	26	1.54	154

NOTES:

1. THIS DESIGN FOR CONTRACTOR BIDDING PURPOSES ONLY.
STATED DIMENSIONS MAY VARY FROM ACTUAL
2. CONCRETE PAD TO BE 3000# PSI AT 28 DAYS (1:2.4 MIX). MAX SIZE AGGREGATE 1 1/2".
3. TOP OF PAD SURFACE TO BE LEVEL FLOAT FINISH PROCESS FOLLOWED BY SLICK STEEL TROWELLING TOOL EDGES.
4. ON CLAY SOIL COMPACT 6" SAND UNDER SLAB.
5. CENTER PRIMARY CONDUITS IN THIS AREA AND INSTALL 1" PVC SLEEVE FOR GROUND ROD.
6. CENTER SECONDARY CONDUITS IN THIS AREA AND INSTALL 1" PVC SLEEVE FOR GROUND ROD.
7. AFTER CONDUITS ARE INSTALLED, SEAL OPENING WITH MORTAR. TAPE OR PLUG CONDUITS OPENINGS.
8. PIER OR BEAMS REQUIRED AS DIRECTED BY TNP ENGINEERING.

ITEM	QTY	MATERIAL DESCRIPTION	M&S	MUN
1	AS REQD	CONCRETE		CUN
2	AS REQD	REINFORCING ROD 3/8"		

TEXAS NEW MEXICO POWER COMPANY
DISTRIBUTION CONSTRUCTION STANDARD

CONCRETE PAD FOR THREE PHASE
PADMOUNT TRANSFORMERS 15KV AND 25KV

APP. _____

DATE: 10/97

UG-5-35

REINFORCING NOT LESS THAN 2" FROM EDGES OF PAD

⊕ GRD. SLEEVE LOCATION

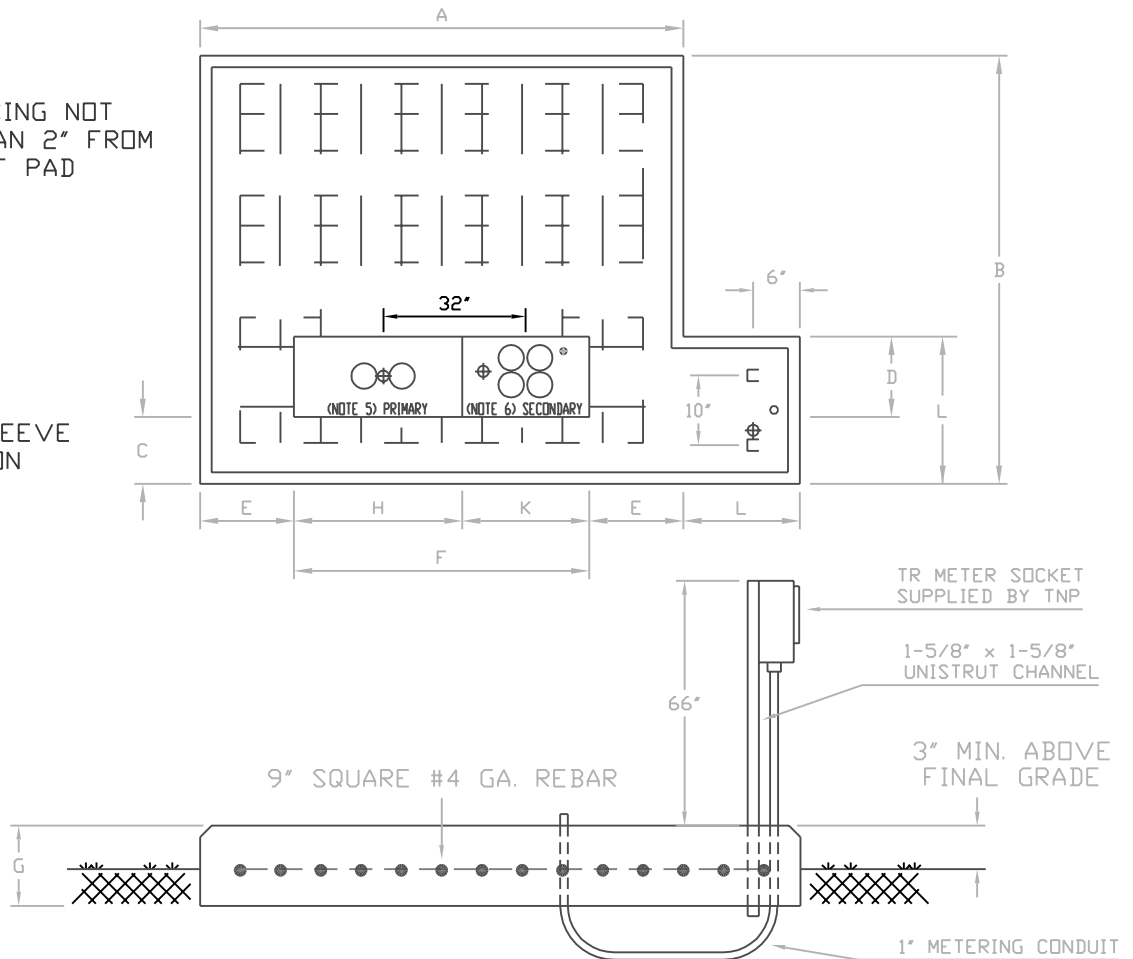

KVA	PAD DIMENSIONS IN INCHES										QUANTITIES	
	A	B	C	D	E	F	G	H	K	L	CONCRETE	REBAR
75 - 500	84	84	6	16	10	64	7	38	26	18	1.0	126
750 - 2500	84	108	10	16	10	64	7	38	26	18	1.54	154

NOTES:

1. THIS DESIGN FOR CONTRACTOR BIDDING PURPOSES ONLY.
STATED DIMENSIONS MAY VARY FROM ACTUAL
2. CONCRETE PAD TO BE 3000# PSI AT 28 DAYS (1.2.4 MIX). MAX SIZE AGGREGATE 1 1/2".
3. TOP OF PAD SURFACE TO BE LEVEL FLOAT FINISH PROCESS FOLLOWED BY SLICK STEEL TROWELLING TOOL EDGES.
4. ON CLAY SOIL COMPACT 6" SAND UNDER SLAB.
5. CENTER PRIMARY CONDUITS IN THIS AREA AND INSTALL 1" PVC SLEEVE FOR GROUND ROD.
6. CENTER SECONDARY CONDUITS IN THIS AREA AND INSTALL 1" PVC SLEEVE FOR GROUND ROD.
7. AFTER CONDUITS ARE INSTALLED, SEAL OPENING WITH MORTAR. TAPE OR PLUG CONDUITS OPENINGS.
8. PIER OR BEAMS REQUIRED AS DIRECTED BY TNP ENGINEERING.

ITEM	QTY	MATERIAL DESCRIPTION	M&S	MUN	CUN
1	AS REQD	CONCRETE			
2	AS REQD	REINFORCING ROD 3/8"			
3	15	UNISTRUT CHANNEL, 1 5/8" x 1 5/8"			
4	8	CONDUIT, 1" PVC	46-0540		
5	2	ELBOW, 1" PVC 90°	46-2790		

 **TEXAS NEW MEXICO POWER COMPANY**
DISTRIBUTION CONSTRUCTION STANDARD

CONCRETE PAD FOR THREE PHASE
PADMOUNT TRANSFORMERS 15KV AND 25KV
WITH CT METERING

APP. _____

DATE: 10/97

UG-5-36

FRONT VIEW

PLANTS TO BE DWARF NATURE. NOT TO EXCEED HEIGHT OF TRANSFORMER.

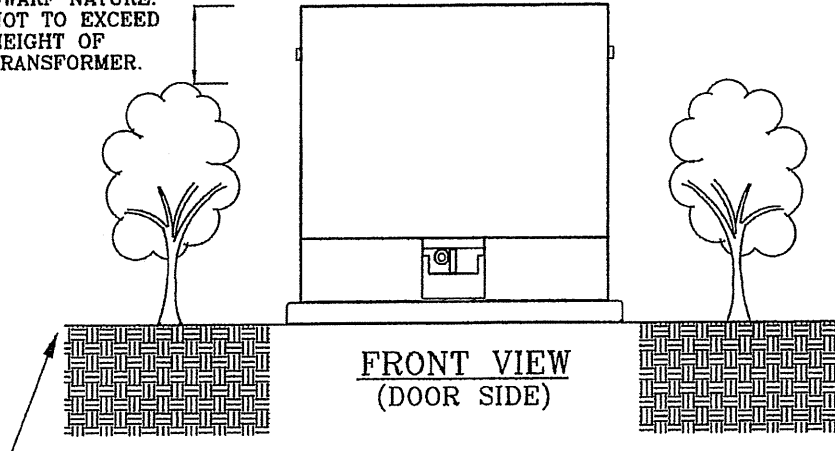

FINAL GRADE TO REMAIN UNCHANGED AROUND TRANSFORMER

LANDSCAPE OR FENCE

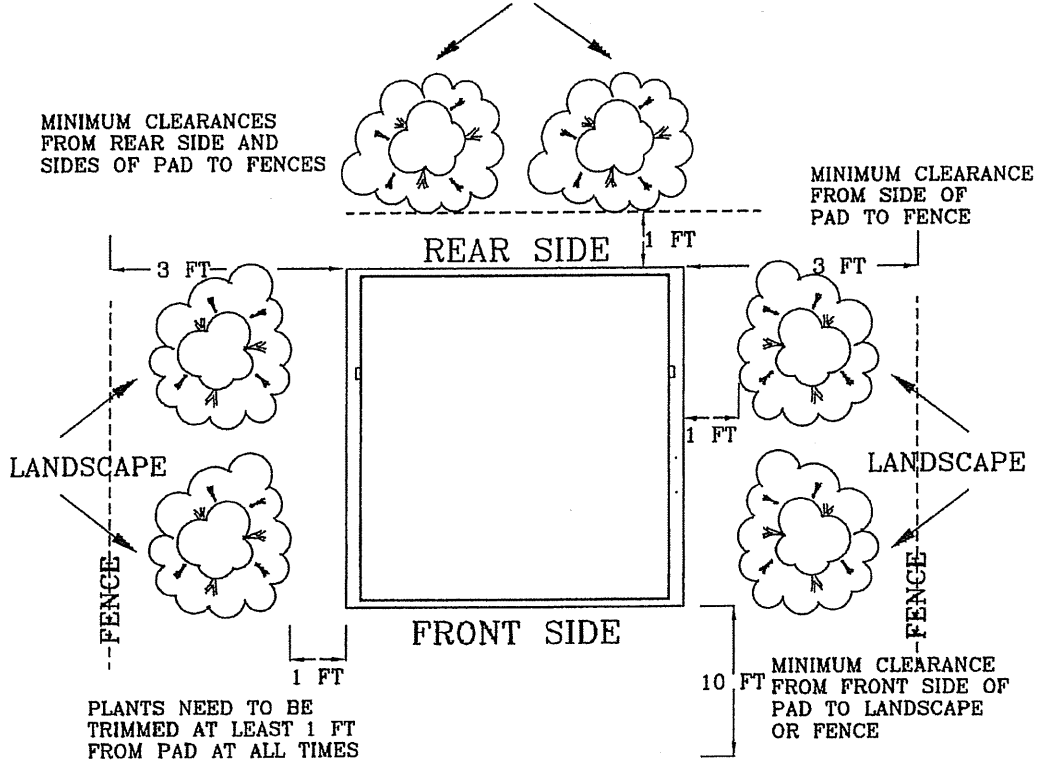

TOP VIEW



TEXAS NEW MEXICO POWER COMPANY
DISTRIBUTION CONSTRUCTION STANDARD

APP. _____

DATE: 8/96

CLEARANCES OF PADMOUNT TRANSFORMERS
FROM LANDSCAPING AND FENCING

UG-2-11

FRONT AND REAR VIEW

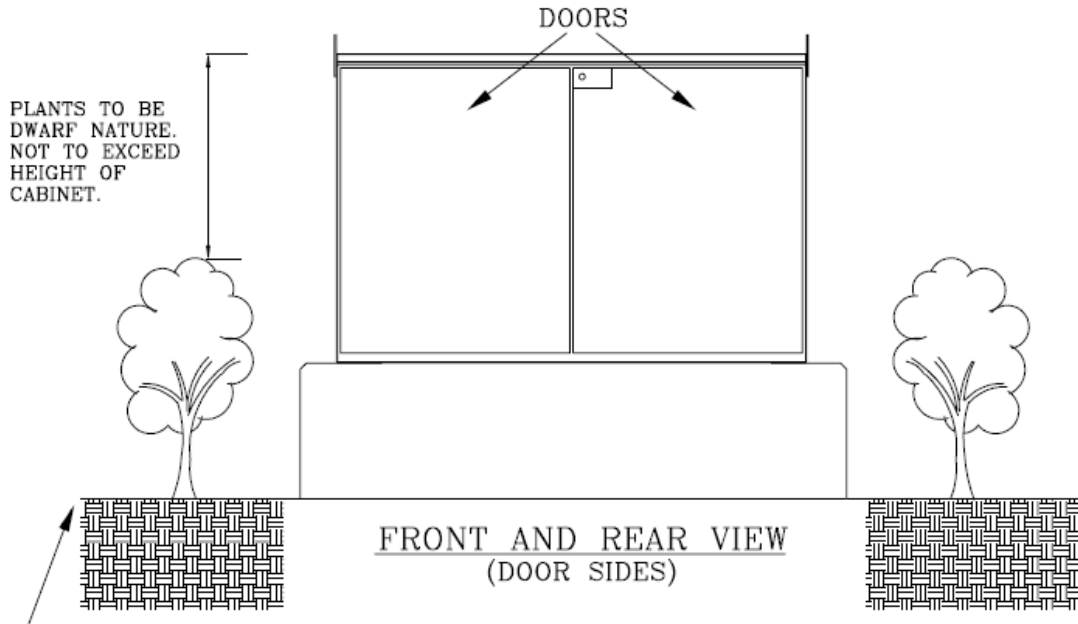

FRONT AND REAR VIEW
(DOOR SIDES)

FINAL GRADE TO REMAIN UNCHANGED
AROUND SWITCH CABINET

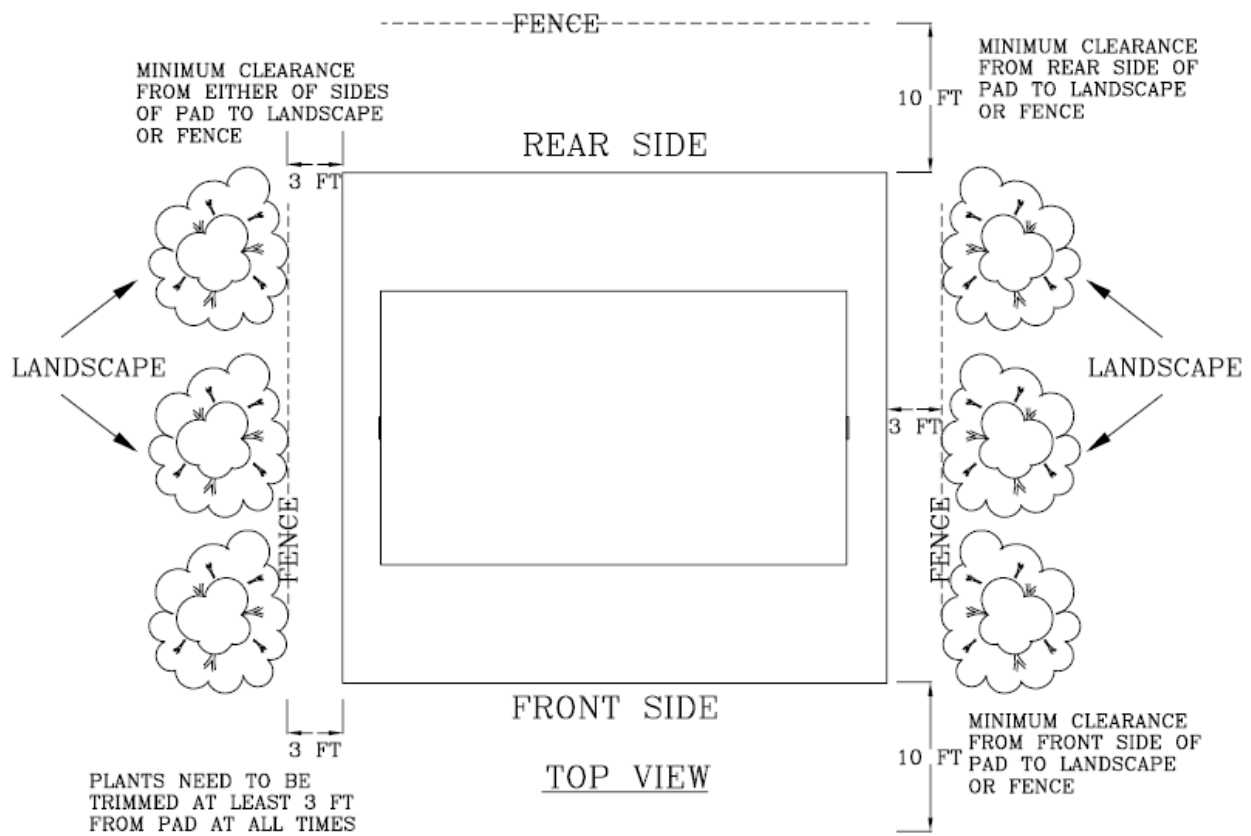

TOP VIEW

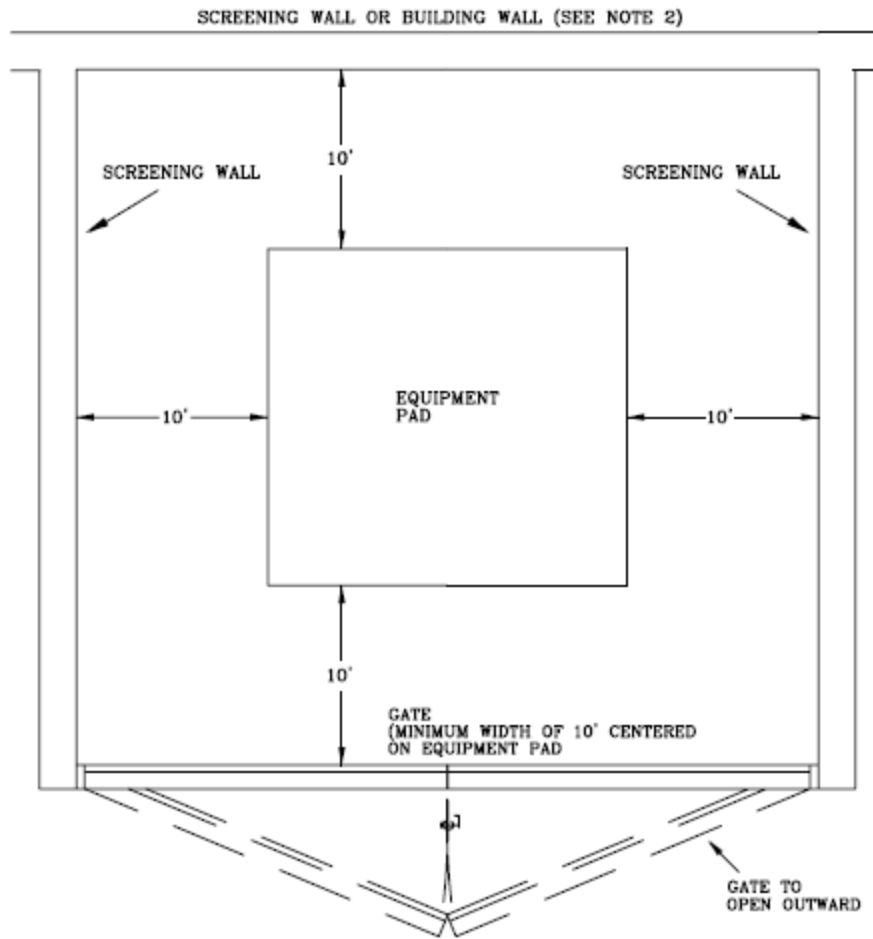

Notes:

1. Distance may be reduced to 5' if equipment side is not used for hot stick switching.
2. Use UG-2-10 for oil filled equipment distances from building walls.
3. If gate is locked, TNMP lock shall be installed.
4. Minimum distance from gate to pad may be reduced to 5' but minimum 10' open area required in front of pad with gate open.
5. When installing a transformer, screening walls shall provide adequate ventilation.

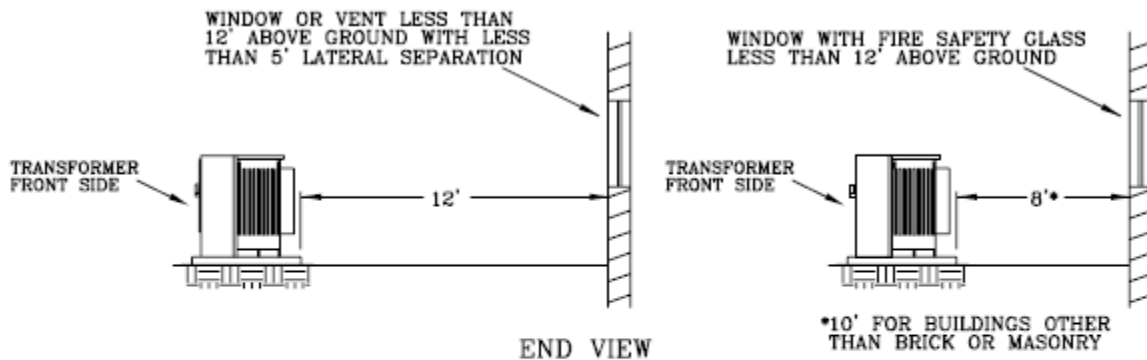
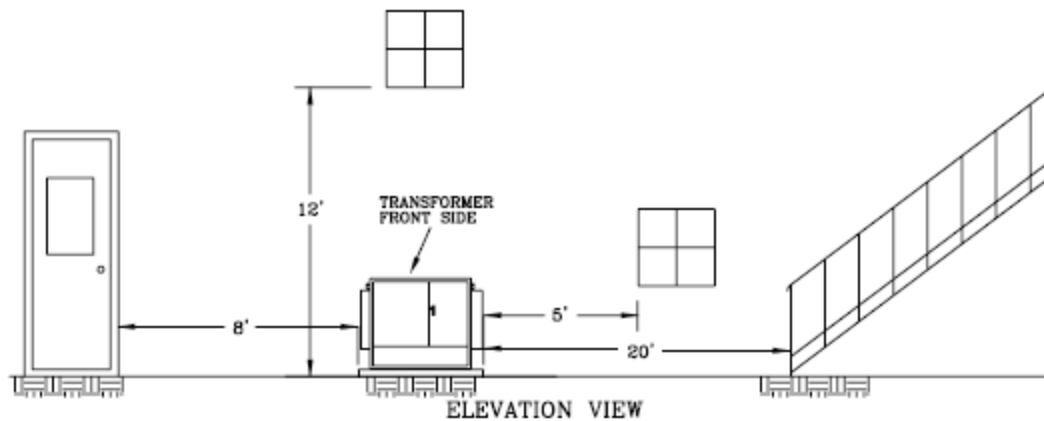
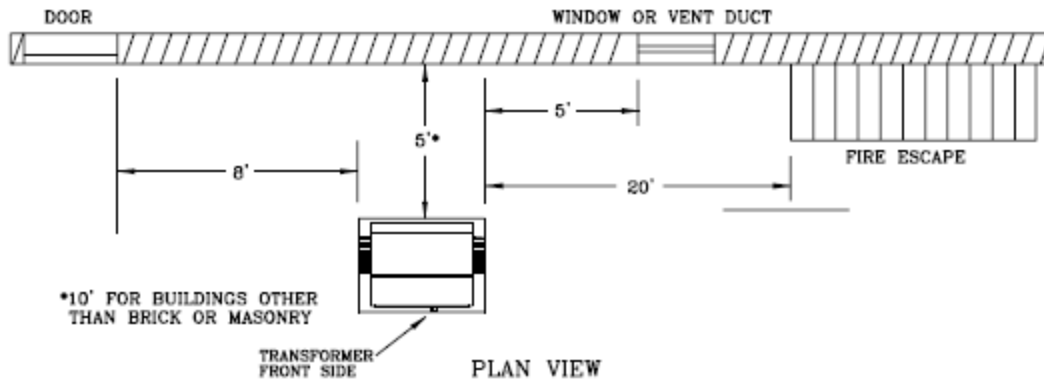

NOTES:

1. ALL DIMENSIONS ARE MINIMUM.
2. MAINTAIN A MINIMUM OF 10' CLEARANCE IN FRONT OF TRANSFORMER FOR ACCESS. ADEQUATE SPACE REQUIRED FOR TRUCKS AND LIFTING EQUIPMENT.
3. APPLIES TO BRICK OR MASONRY BUILDINGS ONLY, EXCEPT WHERE NOTED.
4. DRAINAGE FLOW AROUND TRANSFORMER SHOULD BE AWAY FROM BUILDING.
5. NO COOLING TOWERS, GAS METERS, ETC., WITHIN 5' OF PAD.
6. NO PIPES OR CONDUITS UNDER PAD EXCEPT THOSE REQUIRED FOR TRANSFORMER CONNECTIONS. EXCEPTIONS ALLOWED IF APPROVED BY TNP.
7. NO PART OF BUILDING MAY EXTEND OVER TRANSFORMER.

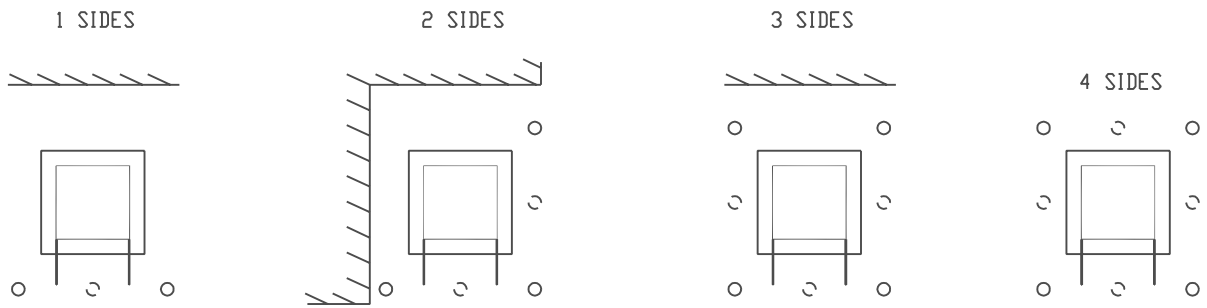

TYPICAL LAYOUT FOR TRAFFIC AND PARKING

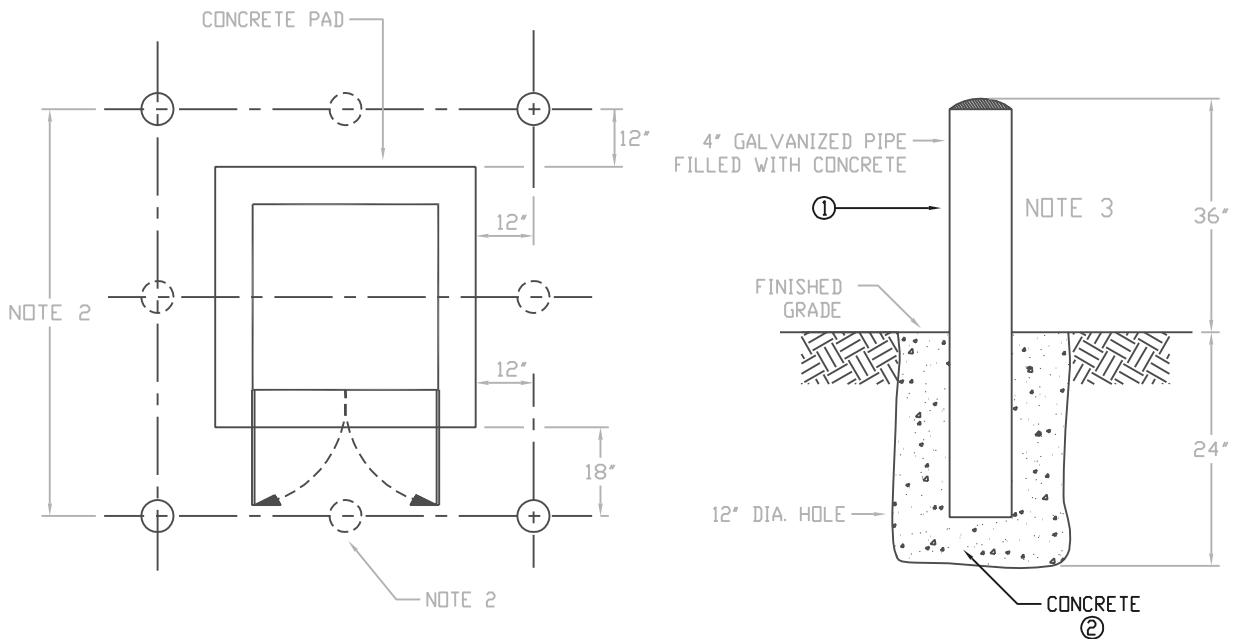

NOTES:

1. INSTALL GUARD POST WHERE PROTECTION FROM DAMAGE DUE TO VEHICLE TRAFFIC IS NEEDED.
2. DISTANCE BETWEEN POSTS SHOULD NOT EXCEED 4 FEET. ADD ADDITIONAL POSTS WHERE NECESSARY TO MEET THIS CONDITION. VERIFY LOCATION OF POST IN FRONT OF TRANSFORMER TO ALLOW FOR DOOR OPENING.
3. INCREASE HEIGHT TO 48" AND DEPTH TO 36" IN TRUCK LOADING AREAS, AND INCREASE SIZE TO 6" GALVANIZED PIPE.

				MUN	
ITEM	QTY	MATERIAL DESCRIPTION	M&S	CUN	
1	AS REQD	CONDUIT, GALVANIZED IRON 4 IN.			
1	AS REQD	CONDUIT, GALVANIZED IRON 6 IN.			
2	AS REQD	CONCRETE			



TEXAS NEW MEXICO POWER COMPANY
DISTRIBUTION CONSTRUCTION STANDARD

APP. _____

DATE: 6/97

GUARD POST INSTALLATION

UG-5-15

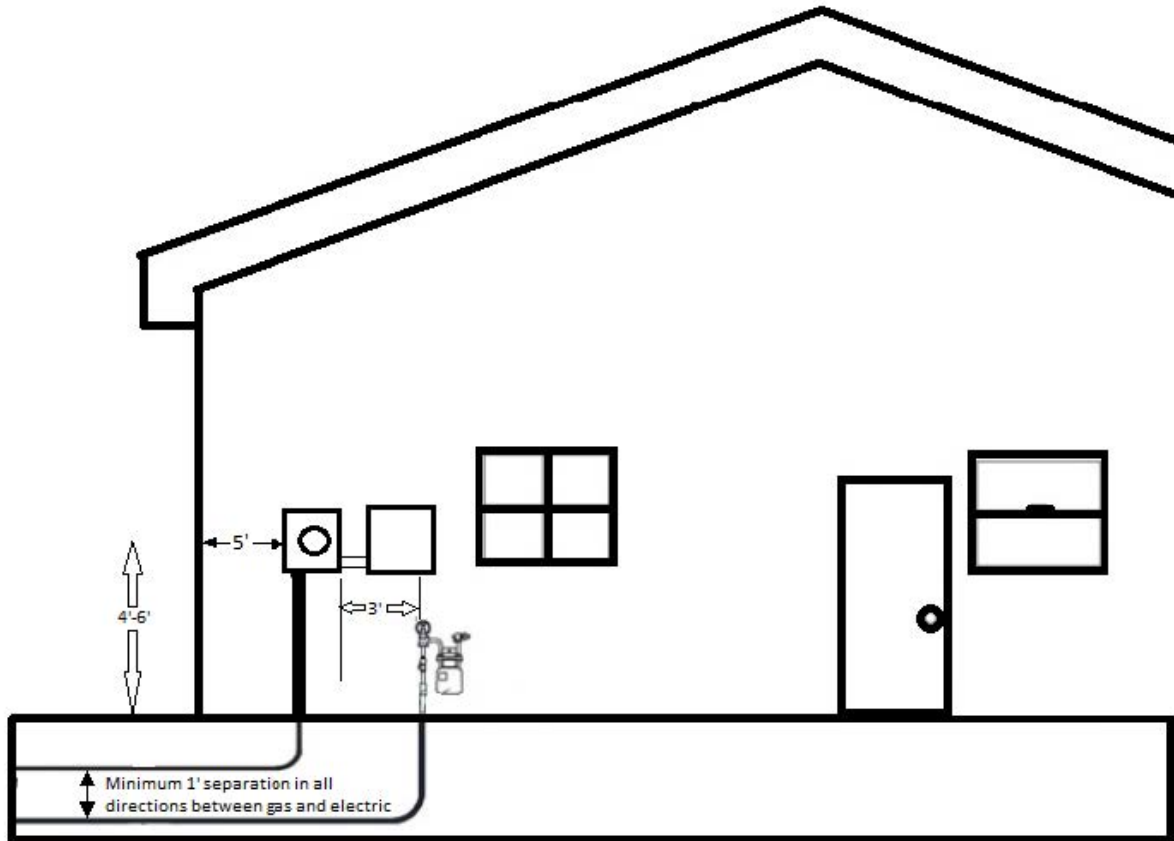

Notes:

1. Meter must have 3 ft horizontal clearance from gas regulator
2. Meter must be between 4' and 6' from final grade
3. Minimum of 1 ft separation in all direction between underground electric conduit and any other utility.
4. Meter must be located with 5 ft of front corner of building.

Note: TNMP will be in connected in the very back of the secondary enclosure. Each new service will be connected in the next available position beginning in the back and moving forward. Service address must be tagged on cables.

911 ADDRESS SHALL BE A MINIMUM 3" LETTERING MARKED ON METER CAN, POLE, OR DURABLE BLACK MATERIAL ATTACHED TO POLE AND SHOULD BE VISIBLE FROM STREET.

MINIMUM CLEARANCE IN FRONT OF SECONDARY ENCLOSURE SHALL BE 4 FOOT.

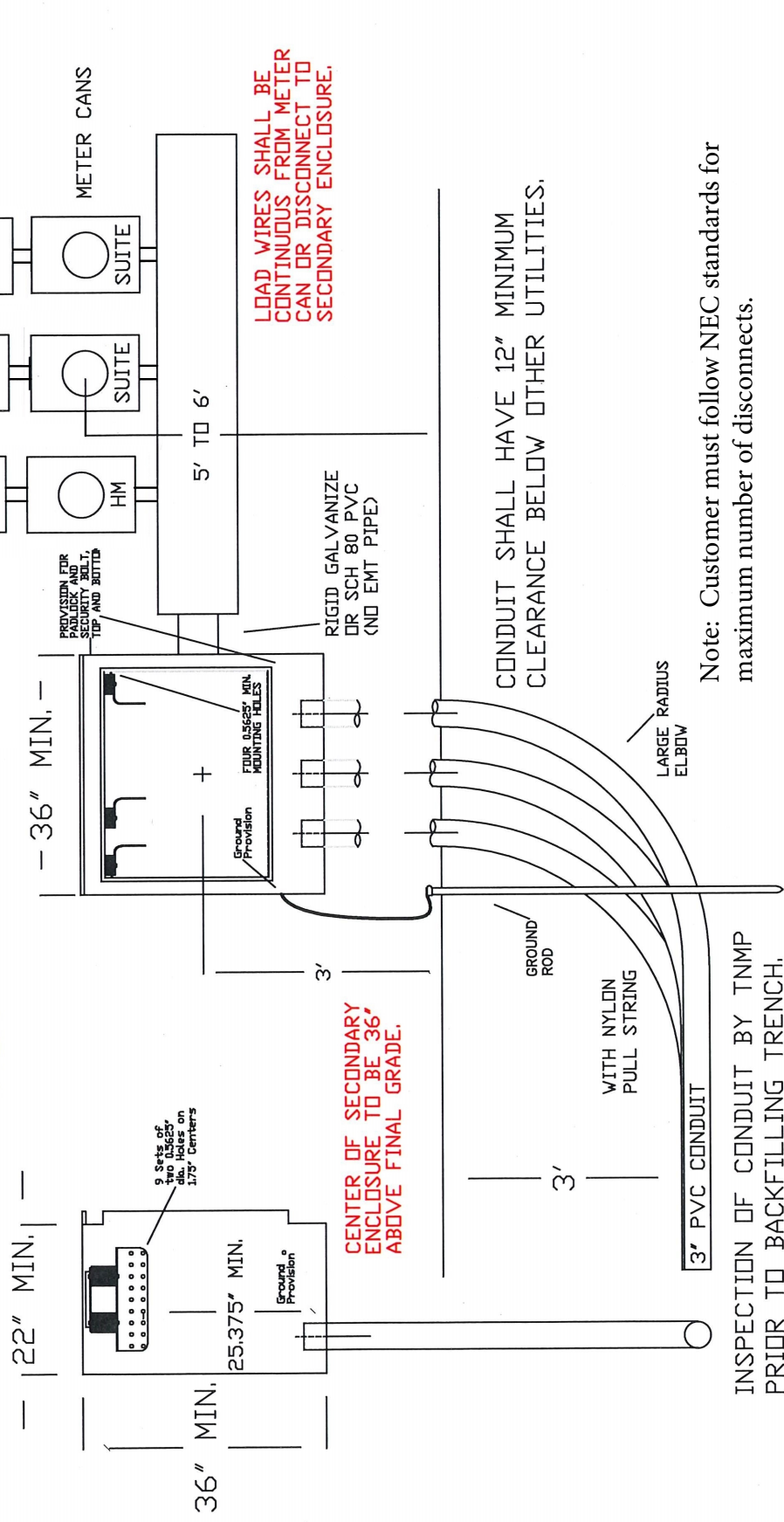

Note: Customer must follow NEC standards for maximum number of disconnects.

INSPECTION OF CONDUIT BY TNMP PRIOR TO BACKFILLING TRENCH.

Dwn. SJB	Ckd. XXX
Date 07-12-16	
Scale NTS	
DWG. NO. XXXX-X-XXXX	

SINGLE-PHASE SECONDARY ENCLOSURE FOR UNDERGROUND SERVICE ENTRANCE



Note: TNMP will be in connected in the very back of the secondary enclosure.
 Each new service will be connected in the next available position beginning in the back and moving forward.
 Service address must be tagged on cables.

911 ADDRESS SHALL BE A MINIMUM 3" LETTERING MARKED ON METER CAN, POLE, OR DURABLE BLACK MATERIAL ATTACHED TO POLE AND SHOULD BE VISIBLE FROM STREET.

MINIMUM CLEARANCE IN FRONT OF SECONDARY ENCLOSURE SHALL BE 4 FOOT.

CUSTOMER TO SUPPLY SERVICE CABLE HOT LUGS IN ENCLOSURE.

CENTER OF SECONDARY ENCLOSURE TO BE 36" ABOVE FINAL GRADE.

LOAD WIRES SHOULD BE CONTINUOUS FROM METER CAN OR DISCONNECT TO SECONDARY ENCLOSURE.

CONDUIT SHALL HAVE 12" MINIMUM CLEARANCE BELOW OTHER UTILITIES.

Note: Customer must follow NEC standards for maximum number of disconnects.

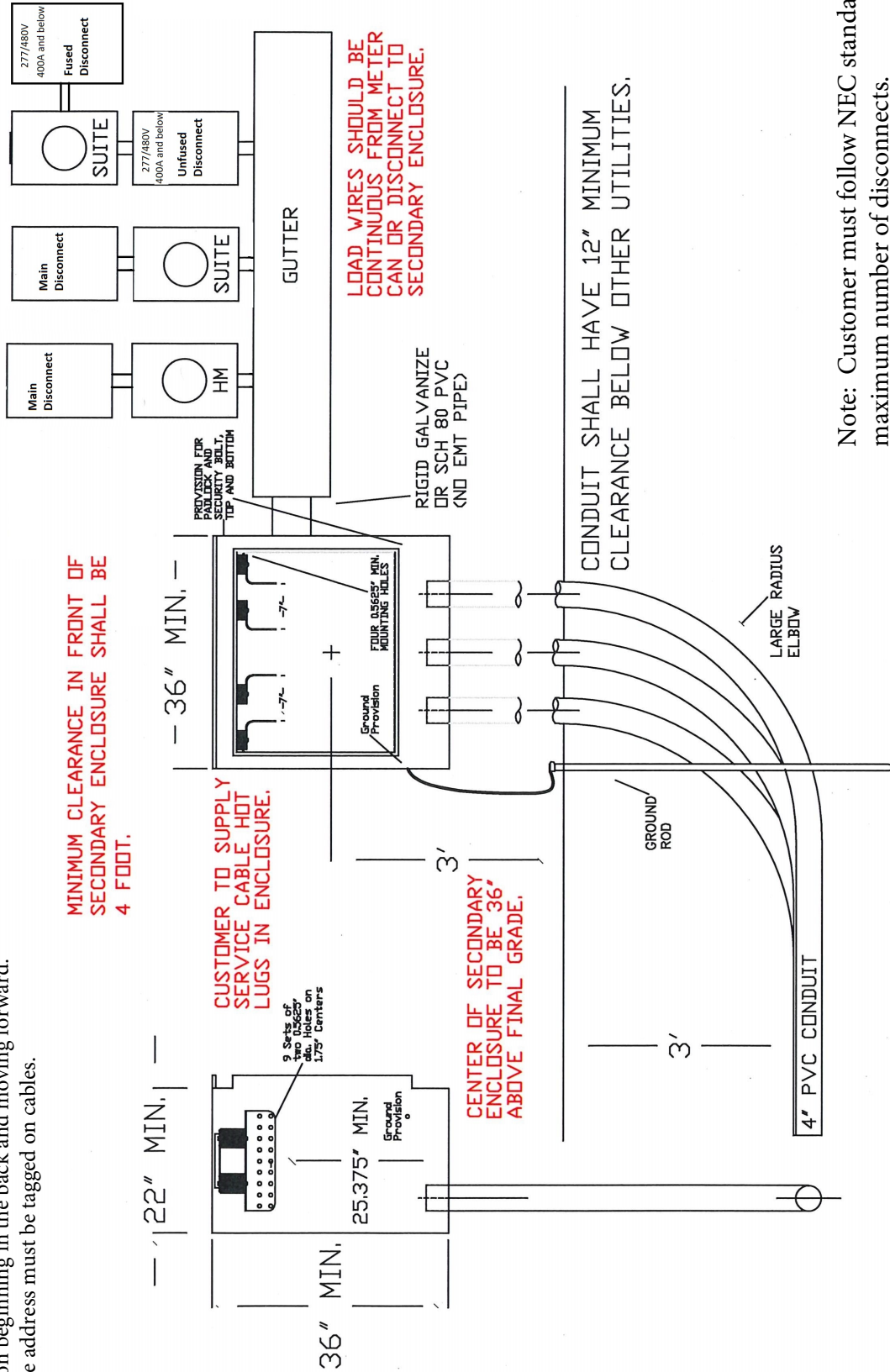

Dwn. SUB	Ckd. XXX
Date XX-XX-XX	
Scale NTS	
DWG. NO. XXXX-X-XXXX	

THREE-PHASE SECONDARY ENCLOSURE FOR UNDERGROUND SERVICE ENTRANCE



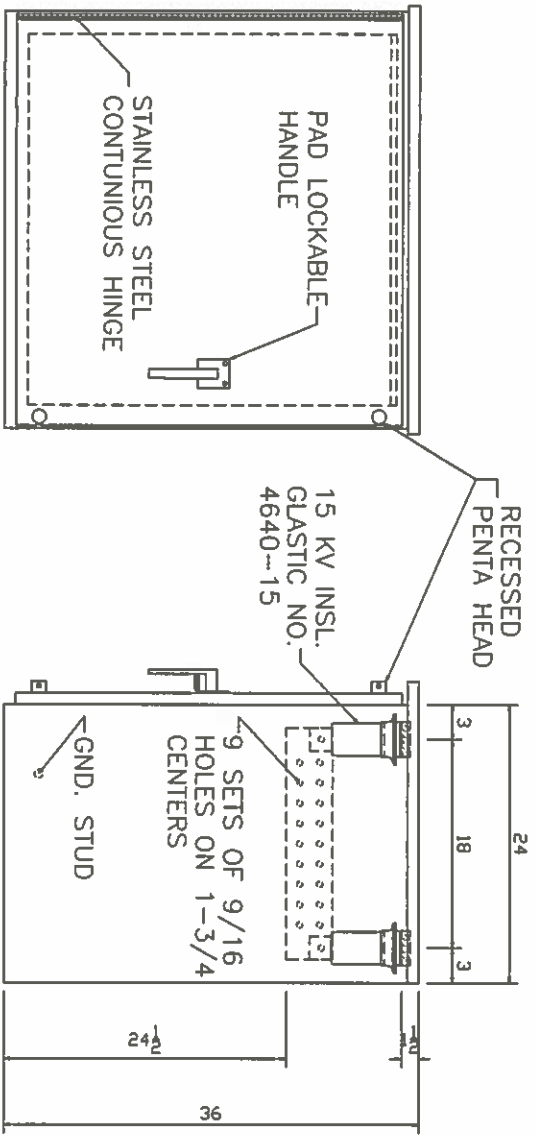

FRONT VIEW

SIDE VIEW

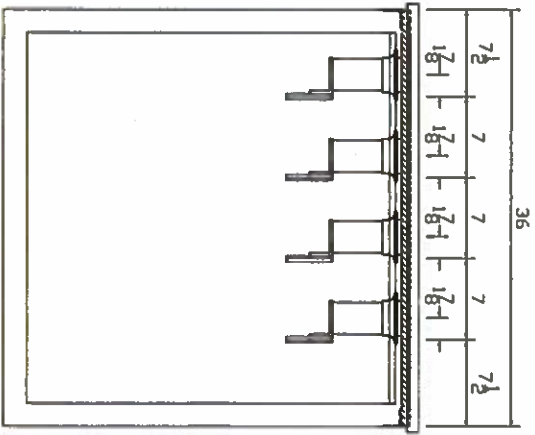

FRONT VIEW LESS DOOR

- NOTES:
1. ENCL. TO BE FABRICATED FROM 12GA. MILD STEEL.
 2. ENCL. TO BE N3R CONSTRUCTION.
 3. ENCL. TO BE POWDER COATED ASA # 61 LT. GRAY.
 4. ENCL. TOP TO BE CROSS BROKE TO SHED WATER.
 5. ENCL. TO HAVE GROUND STUDS ON BOTH SIDES 3" OFF BOTTOM.

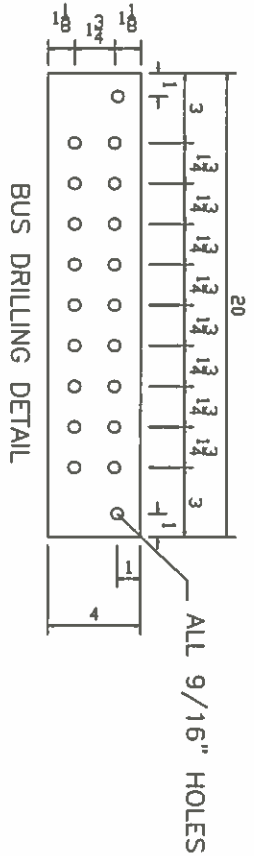

BUS DRILLING DETAIL

**BUSSED CABLE TAP BOX
PER TNMP STANDARDS**

SERVICE: 1200A 3PH 4W 277/480V
 BUS: 1 = 5/16 x 4 CU. BARS PER PHASE
 1 = 5/16 X 4 CU. BARS ON NEUTRAL

LEAGUE CITY 2450 FM 2094 TX. 77573	BUSHI BAN 2450 FM 2094 TX. 77573
DATE ORDERED: 4/13/15 ORDER NO.: DWA	ORDER NO.: DWA
ANDREWS FABRICATION	
BLANCO ELECTRIC	
ORDER NUMBER: A2521-B1	

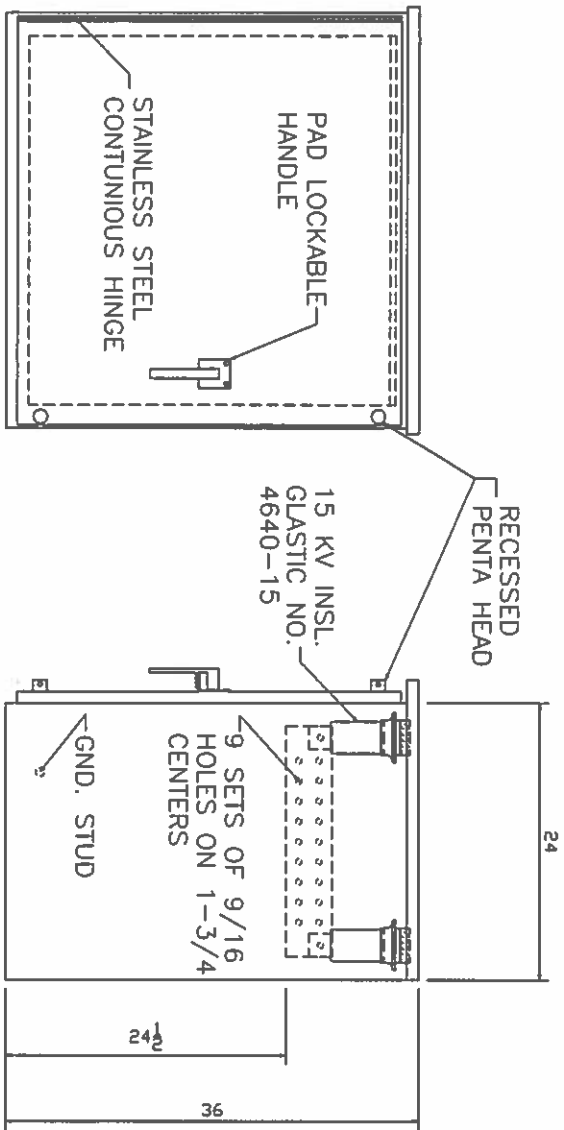

FRONT VIEW

SIDE VIEW

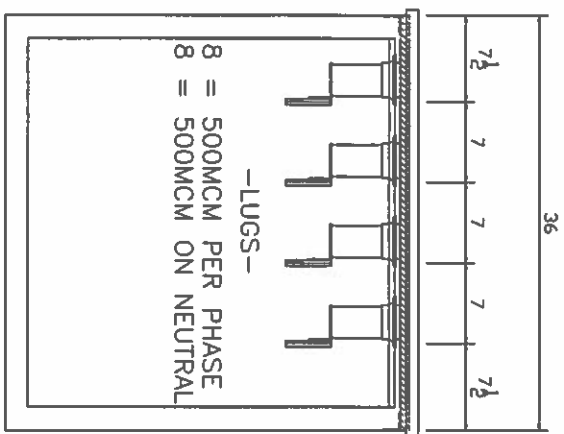

FRONT VIEW LESS DOOR

- NOTES:
1. ENCL. TO BE FABRICATED FROM 12GA. MILD STEEL.
 2. ENCL. TO BE N3R CONSTRUCTION.
 3. ENCL. TO BE POWDER COATED ASA # 61 LT. GRAY.
 4. ENCL. TOP TO BE CROSS BROKE TO SHED WATER.
 5. ENCL. TO HAVE GROUND STUDS ON BOTH SIDES 3" OFF BOTTOM.

BUSSED CABLE TAP BOX
PER TNMP STANDARDS

SERVICE: 2000A 3PH 4W 277/480V
 BUS: 2 = 1/4 x 4 CU. BARS PER PHASE
 2 = 1/4 X 4 CU. BARS ON NEUTRAL

LEAGUE CITY	VICTORY LAKES OUTPARCEL 7
DATE ORDERED: 5/19/10	1615 NORTH FM 646
DATE REC'D:	TX. 77573
	DESIGNED BY: DWA
	ISSUED: 7/12/10
ANDREWS F A B R I C A T I O N	
CIRCLE D INC.	DRAWING NUMBER: A0905-B1

Elliott Wall Mount Secondary Bus Enclosure
 Three-Phase - 600 Volt Class
 Four Single 0.25" x 8" Aluminum Bus
 1,500/1,750 Amp at 30/45 degree C rise over
 40 degree C Ambient

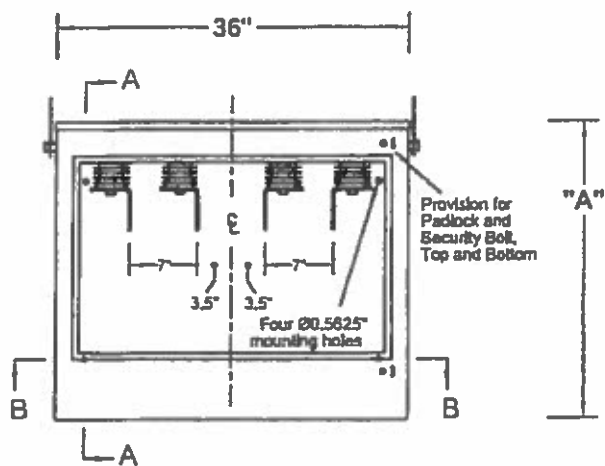

Front View
 Door Removed

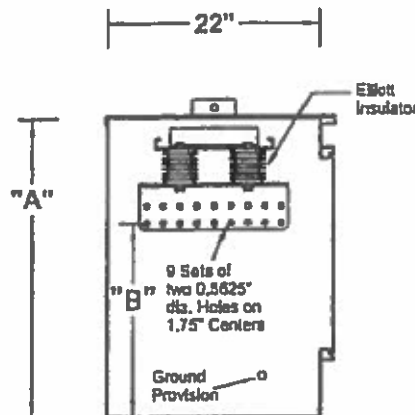

Section AA

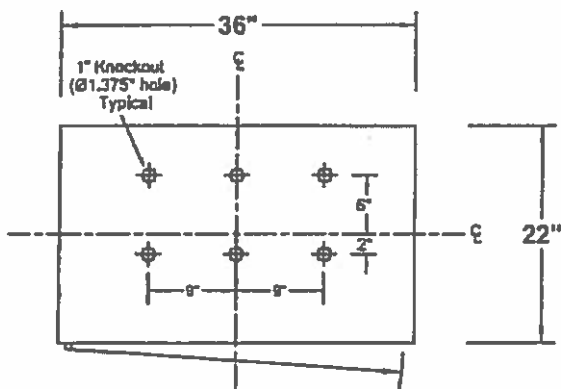

Section BB

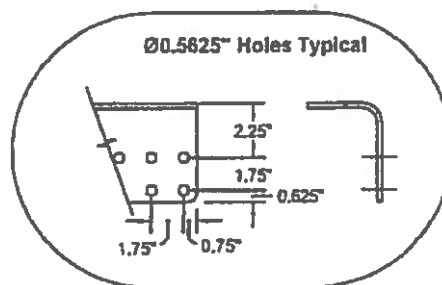

Optional Bus:

Four Single 0.25" x 8" Copper Bus
 2,000/2,300 Amp at 30/45 degree C rise over
 40 degree C Ambient

11-Gauge Steel Enclosure
 Cross-Kinked Top
 Stainless Steel Hinges
 Recessed Stainless Steel Hex Head Security Bolts
 (Recessed Stainless Steel Pan Head Security Bolts Optional)
 3" Min Strike Distance to Ground
 Paint "Light Grey" Munsell #5B9 7.0/0.4

Catalog Number	"A" Dim.	"B" Dim.
EWM-SBE-0.6-331-36W22D-30H-D98282	30"	19.375"
EWM-SBE-0.6-331-36W22D-36H-D98282	36"	25.375"
EWM-SBE-0.6-331-36W22D-42H-D98282	42"	31.375"
EWM-SBE-0.6-331-36W22D-48H-D98282	48"	37.375"

**EWM-SBE-0.6-331-36W22D-"A"H-D98282
 Layout**

Date: 11-5-04	File: d98282r2	Drawing No.:
By: CAS	Approved by: mts	98-282-1R2

Elliott Industries, Inc.
 Bossier City, Louisiana 71171-6388 U.S.A.

Elliott Wall Mount Secondary Bus Enclosure
 Typical Cable Training
 and Mounting Requirements

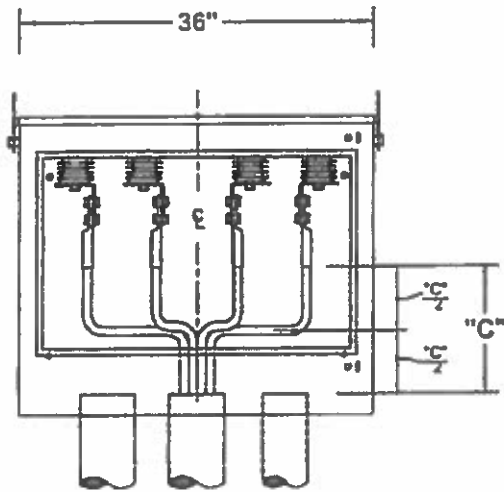

Typical Cable Training

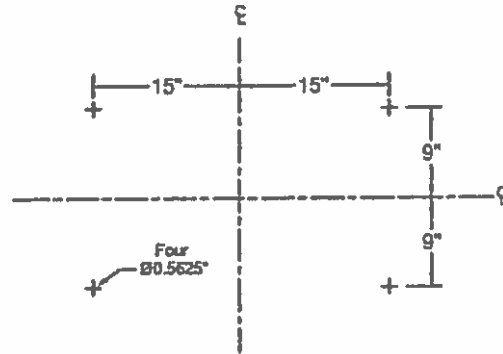

Mounting Hole Locations

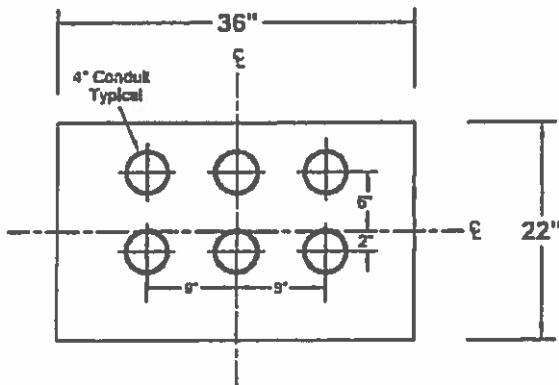

Section BB

EWM-SBE-0.6-331-36W22D-"A" H-D98282		
Typical Cable and Mounting Requirements		
Date: 11-5-04	File: d98282r2	Drawing No.:
By: cas	Approved by: mts	98-282-2
Elliott Industries, Inc.		

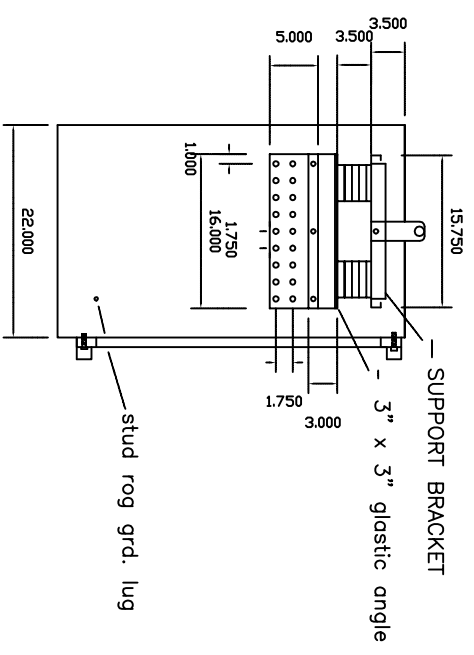
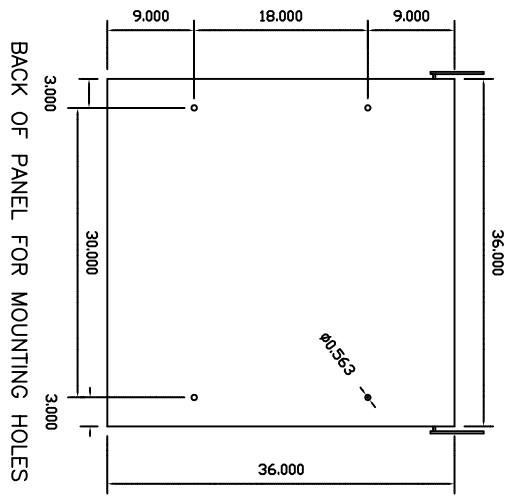
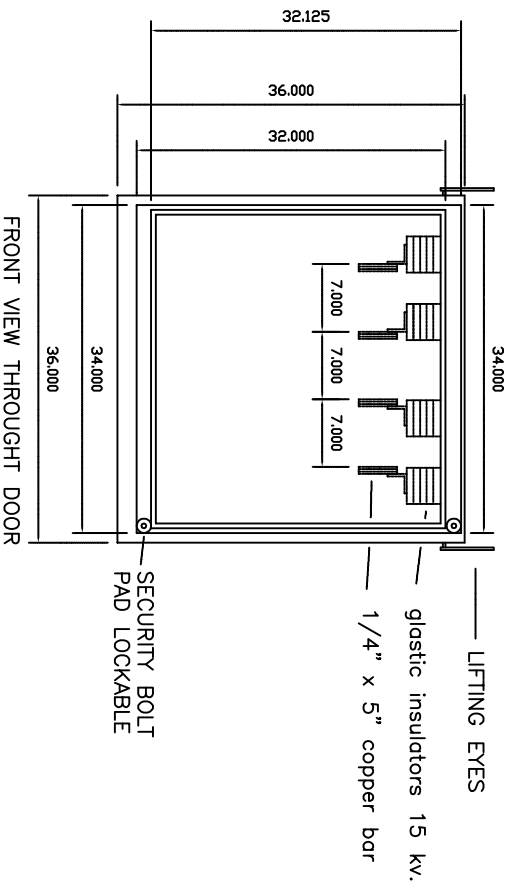

NOTES

1. PANELS TO BE MADE FROM 11 GA. P&O STEEL
2. TOP TO BE CROSS-KINKED
3. MOUNTING HOLES PER DRAWING
4. PAINT ASA#61 LT. GRAY
5. PANEL TO HAVE SECURITY BOLT AND LOCKABLE
6. SERVICE TO BE 800A 3PH/4W 277/480V
7. COPPER TO BE 1PC 4" X 1/4" X 16" PER PH AND NEUTRAL
8. NINE SETS OF HOLES 1-3/4" CENTERS
9. PANEL TO BE NEMA 3 CONST.
10. INSULATORS TO BE GLASTIC NO.4640 15 KV.
11. CU. SUPPORT TO BE 3" X 3" X 3/8" GLASTIC ANGLE

SCALE:	APPROVED BY: CENTERPOINT	DRAWN BY:
DATE:		REVISED:
 IAL ELECTRICAL CONTROLS <small>OF HOUSTON, INC.</small>		
		DRAWING NUMBER

Overhead Secondary Enclosures

Part Number	Description
■ MILBANK S8341-X	ENCLOSURE, SERVICE, 0-600A, 600V, 3W 1PH, MULTI-MTR INSTALLATIONS, 1-4" OPENING, 16 X 24 X 6"
■ DURHAM 1004120A	ENCLOSURE, SERVICE, 0-1100A, 3 WIRE, 1 PH INSTALLATION, CONVERT TO 4 WIRE INSTALLATION BY ADDING EXTRA CONNECTOR TSN 320781, 12 X 50 X 8"
■ SUPERIOR	ENCLOSURE, SERV, TO 1200A, 600V, 4W,
■ TECHNOLOGY	3PH, MULTI MTR INSTALLATIONS, 4 4"
■ RPW19701BA	OPENINGS W/CLOSING PLATE, 30 X 42 X 14"
■	CLOSING PLATE, 30 X 42 X 14 IN
■ MILBANK S8333-6X	ENCLOSURE, SERV, 600V, 3PH, 4W, or MULTI METER INSTALLATIONS, 1200-2500A,
■ DURHAM 1005112	6 4" HUB OPENING W/CLOSING PLATE, 44 X 52 X 24", 4 HORIZ BUS BARS W/NEMA HOLES & INTEGRAL SET SCREW CONNECTORS

OVERHEAD SERVICE TO TWO OR MORE SECONDARY SERVICE METERS

NOTES:

1. A service enclosure installed by Customer on outside wall of building, is required for Secondary Service installations through 1500 amperes with two or more meter sockets. Contact Company for determination of service enclosure requirements.
2. Service head, service raceway and main service entrance conductors provided, installed and maintained by Customer. Line side conductors from weatherheads are to contact the center of bus bars. Load conductors to meter sockets to be connected equally on both ends of bus bars to obtain full current ratings.
3. Conductors and raceways provided, installed, and maintained by Customer.
4. Meter sockets shall be provided, installed and maintained by Customer.
5. For use of service voltages through 480 volts.
6. Service entrance conductors to be continuous from meter sockets to service enclosure
7. Customer provides all connectors and makes all connections in the enclosure. Approved connectors, plated 3/8" minimum diameter bolts, Belleville washers, and oxide inhibitor are required for connections to plated aluminum bus.
8. Service drop clearances must meet TNMP and NESC specifications.
9. Service switches, when installed near the service enclosure, should not interfere with service to an occupancy.
10. Service entrance conductors to extend from weatherhead to service landing, but in no case less than 24" minimum. Service Head(s) shall be located within 2' of service landing attachment. No more than three service mast allowed without prior Company approval.
11. Customer installs service drop attachment of adequate strength for Company's service drop conductors.
12. Insulated conduit bushings are required for raceways terminating in the meter base.
13. The use of flexible metallic conduit for service entrance raceway is prohibited.
14. Each socket must be clearly and permanently marked to indicate each apartment or location being served.
15. The use of Schedule 80 PVC for service mast not supporting service drop is allowed unless prohibited by the local inspecting authority.

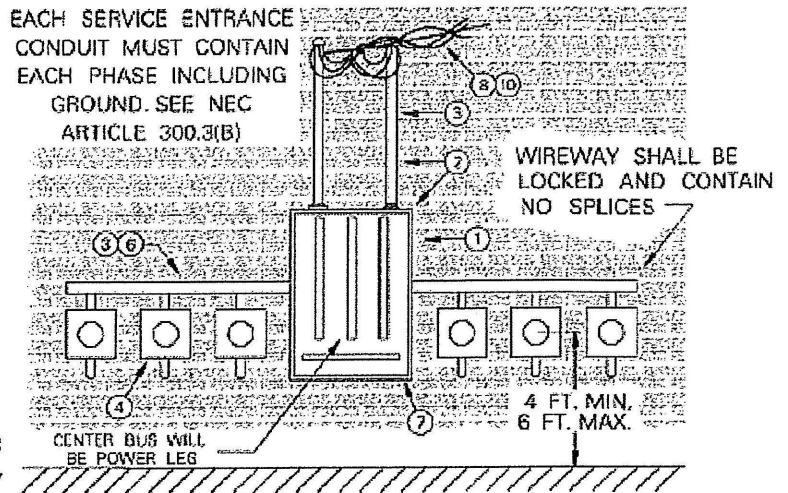

Approved Texas-New Mexico Power Co. Meter Sockets

Milbank Mfg.
Co.

Sockets Only - Order Hubs Separately

Residential - Overhead

100 Amp
200 Amp

URS1204-G-HO
U42542-HO

UTRS101B
UTRS202B

UTRS101B-CH
UTRS202B-CH

UTRS101B-MEP
UTRS202B-MEP

UTRS101B-SQD
UTRS202B-SQD

R114A11B-T
R214B11B-T

Anchor Electric

Durham

Cutler Hammer

Midwest

Square-D

Weigmann

Residential - Underground

100 Amp
200 Amp

U7588-XL
U1980-O

W/4" Side Wireway

UTRS111B
UTRS229A

UTRS111B-CH
UTRS229A-CH

UTRS111B-MEP
UTRS229A-SQD

R114A12B-T
R214C13A-T

Residential - Multiple Position

150 Amp End Feed

2-Gang
3-Gang
4-Gang
5-Gang

U1233-RXL
U1234-RXL

UT2R5432B
UT3R5432B
UT4R5432B

UT2R5432B-CH
UT3R5432B-CH
UT4R5432B-CH

UT2R5432B-MEP
UT3R5432B-MEP
UT4R5432B-MEP

UT2R5432B-SQD
UT3R5432B-SQD
UT4R5432B-SQD

R514L27B-T
R514L37B-T
R514L47B-T
R514L57J-T
R514L26B-T
R514L36B-T
R514L46J-T
R514L56J-T
R514M66J-T

150 Amp Center Feed

2-Gang
3-Gang
4-Gang
5-Gang
6-Gang

U1236-RXL
U1252-X-K1
U1253-X-K2
U1254-X-K3
U1255-X-K4
U1256-X-K4

UT2R5132B
UT3R5132B
UT4R5132B
UT5R5132B
UT6R5432T
UT7R2332T
UT8R2332T
UT9R2332T
UT10R2362T
UT11R2392TT
UT12R2392TT

UT2R5132B-CH
UT3R5132B-CH
UT4R5132B-CH
UT5R5132T-CH
UT6R5432T-CH
UT7R2332T-CH
UT8R2332T-CH
UT9R2332T-CH
UT10R2362T-CH
UT11R2392TT-CH
UT12R2392TT-CH

UT2R5132B-MEP
UT3R5132T-SQD
UT4R5132B-SQD
UT5R5132T-SQD
UT6R5432T-SQD
UT7R2332T-SQD
UT8R2332T-SQD
UT9R2332T-SQD
UT10R2362T-SQD
UT11R2392TT-SQD
UT12R2392TT-SQD

200 Amp

320 Amp

Overhead Only
Overhead or Underground

U1079-R
U2448-X

U44542-HLO

UTH4300T
UTH4330T

UTH4300T-CH
UTH4330T-CH

UTH4300T-MEP
UTH4330T-MEP

UTH4300T-SQD
UTH4330T-SQD

R314E11J-LT
R314E14J-LT

Commercial - Single Phase

3 Wire

200 Amp

W/Bypass Jaw Clamping
W/Center Phase Disconnect

U9880-RL

UD2052-HO

UTH5213B-ND
UTH5213B-ND-CH

UTH5213B-ND-MEP
UTH5213B-ND-SQD

UTH5213B-ND-SQD

R235C12B-LNT

4 Wire

100 Amp
200 Amp

W/ Bypass, Non Jaw Clamping
W/Bypass, Jaw Clamping

U8100-RL
U7423-XL
U9701-RL
U2594-X

U22572-HO
UD2072-HO/HLO

UTH7213B/T
UTH7330T

UTH7213B/T-CH

UTH7213B/T-MEP

UTH7213B/T-SQD

R237C12B-LT

4 Wire Multi-Position

200 Amp

2-Gang
3-Gang
4-Gang
5-Gang
6-Gang

U2734-XT

UT2H72353T
UT3H72353T
UT4H72393TT
UT5H72393TT
UT6H72393TT

UT2H72353T-CH
UT3H72353T-CH
UT4H72393TT-CH
UT5H72393TT-CH
UT6H72393TT-CH

UT2H72353T-MEP
UT3H72353T-MEP
UT4H72393TT-MEP
UT5H72393TT-MEP
UT6H72393TT-MEP

UT2H72353T-SQD
UT3H72353T-SQD
UT4H72393TT-SQD
UT5H72393TT-SQD
UT6H72393TT-SQD

R237N26J-LT
R237N36J-LT
R237U46R-LT
R237U66R-LT
R237U66R-LT

MAIN
DISCONNECT 320A URD

FUSED MAIN
DISCONNECT

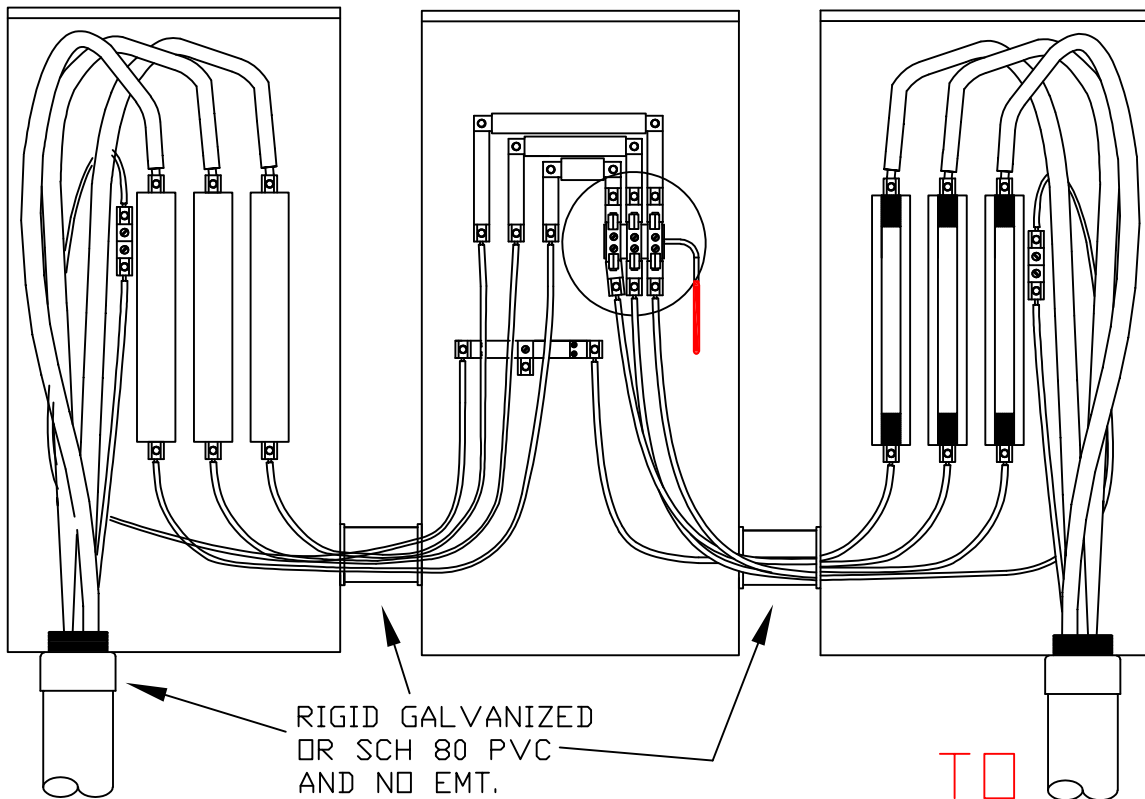

4-WIRE SERVICE
FROM TRANSFORMER

TO
BREAKER
PANEL



320A AND SMALLER THREE-PHASE
UNDERGROUND 277/480V
INSTALLATION

Dwn. XXX	Ckd. XXX
Date XX-XX-XX	
Scale NTS	
DWG. NO. XXXX-X-XXXX	

**TEXAS-NEW MEXICO POWER COMPANY
TARIFF FOR RETAIL DELIVERY SERVICE**

6.1. Rate Schedules

Applicable: Entire Certified Service Area

Effective Date: January 1, 2019

Page No. 150

Revision 11

6.1.2.2 CONSTRUCTION CHARGES**6.1.2.2.1 EXTENSIONS OF ELECTRIC SERVICE**

Company is responsible for the construction, extension, upgrade, or alteration of Delivery System facilities necessary to connect Retail Customer's Point of Delivery to Company's Delivery System in conjunction with Section 5.7, FACILITIES EXTENSION POLICY and the terms and conditions contained herein. Company makes extension of Delivery System facilities to Retail Customer's electrical installation so as to minimize the cost of such extension. In instances where the cost of the requested extension, installation or modification of Company's facilities is in excess of the standard allowances stated herein, or where the installation of non-standard facilities is requested, a Contribution In Aid of Construction ("CIAC") is required from the Retail Customer.

A. STANDARD DISTRIBUTION FACILITIES

Company's standard distribution facilities consist of the Delivery System facilities necessary to transport electric power and energy from a single, single-phase or three-phase distribution source to Retail Customer at one Point of Delivery via radial line, with one standard Company meter, at one of Company's available standard voltages. The service wire and meter will be of sufficient size characteristics to properly deliver and account for the electric power and energy consumed, as is reasonably practicable.

B. NON-STANDARD DISTRIBUTION FACILITIES

Non-standard facilities may include but are not limited to a two-way feed, automatic and manual transfer switches, Delivery Service through more than one Point of Delivery, redundant facilities, facilities in excess of those normally required for Delivery Service, or facilities necessary to provide Delivery Service at a non-standard voltage.

C. POLICY

1. In determining whether or not a contract and/or non-refundable CIAC is required, the Company may consider several factors, including, but not limited to, the size of the projected load, the revenue the projected load will

**TEXAS-NEW MEXICO POWER COMPANY
TARIFF FOR RETAIL DELIVERY SERVICE**

6.1. Rate Schedules

Applicable: Entire Certified Service Area

Effective Date: January 1, 2019

Page No. 151

Revision 11

- generate, the Company's investment in the project, the likely permanence of the load, and the credit worthiness of the prospective customer.
2. To insure existing customers are not unfairly burdened by a proposed extension of services, the Company may alter the method of determining the Allowance. An Allowance is derived from a determination by the Company of the amount of investment supported by the customer's projected load, historical comparisons of similar loads in the same geographic region, and/or the failure rate of similar extensions to achieve permanence or generate revenue comparable to projections. Other similarly important factors may influence the actual Allowance the Company permits.
 3. A Retail Customer requesting an extension of the Company's Delivery System facilities for an installation which in the judgment of the Company is of temporary occupancy or use (less than 12 months) will pay a CIAC prior to construction. The CIAC for such installations will equal the total cost of the facilities extension.
 4. In the event a line extension is required, any construction cost options such as sharing of construction costs between the Company and the customer, or sharing of costs between the customer and other applicants shall be explained to the customer following assessment by the Company of necessary line work.
 5. Easements and rights-of-way: all extensions shall be constructed on private easements or rights-of-way. Where private easements or rights-of-way are not available, such lines may be constructed on existing public roads, streets, alleys, easements or rights-of-way. New customers shall furnish rights-of-way or easements in a form acceptable to Company as required, without charge to the Company, over property owned or leased by such new customers and will assist the Company in securing other rights-of-way or easements necessary to provide service.
 6. Pursuant to Section 5.7.2, CONTRACTUAL ARRANGEMENTS, the Company may, at its option, enter into a Facilities Extension Agreement with

**TEXAS-NEW MEXICO POWER COMPANY
TARIFF FOR RETAIL DELIVERY SERVICE**

6.1. Rate Schedules

Applicable: Entire Certified Service Area

Effective Date: January 1, 2019

Page No. 152

Revision 11

the customer, to assure that existing customers are not unfairly burdened in any way by the required investment.

7. Pursuant to Section 5.7.2, CONTRACTUAL ARRANGEMENTS, the Company shall at all times have title to, complete ownership of and control over facilities installed by the Company or its contractors. Company may use any such facilities to serve other customers when Company determines it is feasible to do so. A nonrefundable CIAC or any other project cost sharing mechanism does not give Competitive Retailer or Retail Customer or any survivors, any rights to Company facilities except as may be made by separate agreement.

D. DEFINITIONS

1. Contribution in Aid of Construction (CIAC). A payment from Retail Customer, required prior to construction, for line extension projects whose project costs exceed the customer's Standard Allowance, if applicable.
2. Project Investment. The cost to the Company of extending the requested service, reduced by the cost of readily salvageable items.
3. Cost of the Extension. Another way of referring to the Project Investment.
4. Standard Allowance. Standard dollar allowance used to offset the Cost of the Extension.

6.1.2.2.2 STANDARD FACILITY EXTENSIONS

Extensions of Standard Facilities to permanent Retail Customers within the Company's certificated area where the estimated cost to extend facilities does not exceed the Standard Allowances stated herein, will be provided to Retail Customer at no cost. The Cost of the Extension is calculated by the Company using the route of the new line, as determined by the Company, from Company Delivery System facilities to the Retail Customer's point of delivery, and includes the cost of all Standard Facilities required to provide service to the customer. If the Cost of the Extension exceeds the Standard allowances stated herein, the Retail Customer will pay a non-refundable CIAC for the Cost of the Extension in

**TEXAS-NEW MEXICO POWER COMPANY
TARIFF FOR RETAIL DELIVERY SERVICE**

6.1. Rate Schedules

Applicable: Entire Certified Service Area

Effective Date: January 1, 2019

Page No. 153

Revision 11

excess of the stated allowances. In cases where a non-refundable CIAC is required, full payment of the CIAC must be received prior to construction.

A. FACILITIES EXTENSION AGREEMENT

The Company may require execution of a Facilities Extension Agreement ("Agreement") before construction of the facilities may begin. This Agreement will set forth the terms and conditions of the extension and will specify the Project Investment, Standard Allowance, CIAC, and may require a letter of credit or surety to secure the amount of the Standard Allowance. The Agreement term will be for a period of up to 36 months (3 years).

B. FUNDING ARRANGEMENTS

1. The Company may require the Retail Customer to provide a letter of credit or other surety to secure the amount of the Standard Allowance prior to beginning construction. The amount of the surety will be equal to the Standard Allowance.
2. If acceptable to Company, the Retail Customer may establish a cash escrow account in lieu of other surety with the Company as beneficiary to the account. The arrangement must be approved by the Company before construction may begin. In addition, the applicant may be required to execute an Agreement setting forth the terms and conditions of the account arrangements. The amount of the escrow account will be equal to the Standard Allowance.
3. If the Retail Customer does not develop the number of lots or realize the maximum kW load that was used to compute the Standard Allowance and resulting CIAC, then the Retail Customer must pay an Under-Utilization charge at the end of the Agreement term. This Under-Utilization charge will be equal to the difference between the CIAC initially computed, and the Allowance and resulting CIAC as recalculated based on the number of lots built, sold and occupied, or maximum kW actually realized.

**TEXAS-NEW MEXICO POWER COMPANY
TARIFF FOR RETAIL DELIVERY SERVICE**

6.1. Rate Schedules

Applicable: Entire Certified Service Area

Effective Date: January 1, 2019

Page No. 154

Revision 11

6.1.2.2.3 STANDARD ALLOWANCE FOR LINE EXTENSIONS**A. CONTRIBUTIONS IN AID OF CONSTRUCTION (CIAC)**

Retail Customers may be required to provide a **non-refundable** Contribution in Aid of Construction ("CIAC") to extend electrical facilities to a customer's Point of Delivery as determined in the formula below. If the amount calculated is zero or negative, no CIAC is required. To the extent that the CIAC payment is considered taxable revenue to the Company, the CIAC shall include an amount equal to the Company's tax liability. The Company will install, own, operate and control all facilities necessary to provide electrical service to the Point of Delivery. The Project Investment will include all standard facilities, meters, services and transformers. Facilities not included in the Project Investment are those necessary to accommodate future growth considerations or Company initiated reliability enhancement projects.

The CIAC required is based on the formula:

$$\text{CIAC} = (\text{Project Investment} - \text{Standard Allowance}) + \text{Company's Tax Liability}$$

B. STANDARD ALLOWANCES

The method for determining Standard Allowance is as follows:

**Residential and Small Commercial/Industrial loads with Maximum Demands
less than 9 kW**

Allowance = \$3,000 per End-Use Customer

Secondary Commercial/Industrial Loads over 9 kW

Allowance = \$182/kW (based on Maximum kW)

Primary Service

Allowance = \$113/kW (based on Maximum kW)

The determination of Maximum kW for the Standard Allowances is based on historical data from residences or businesses of similar size and function in that region of the

**TEXAS-NEW MEXICO POWER COMPANY
TARIFF FOR RETAIL DELIVERY SERVICE**

6.1. Rate Schedules

Applicable: Entire Certified Service Area

Effective Date: January 1, 2019

Page No. 155

Revision 11

state. Consideration is given to customer-owned equipment data supplied prior to the determination of a CIAC.

Under no circumstance shall any unused allowance be paid or credited to the Retail Customer or used to reduce the cost for installation of non-standard distribution facilities or non-standard street lighting facilities.

6.1.2.2.4 NON-STANDARD FACILITY EXTENSIONS

- A. If an existing or prospective Retail Customer requires or requests services which involve Non-Standard Facilities as described in Section 6.1.2.2.1.A of this tariff, the Retail Customer will be required to pay a non-refundable CIAC equal to the total cost of the installation of the Non-Standard Facilities. This CIAC must be paid prior to the construction of the Non-Standard Facilities.
- B. Pursuant to Section 5.7.2, CONTRACTUAL ARRANGEMENTS, the Company may terminate the provision of any Delivery Service utilizing non-standard facilities at the end of the contract term, or in the absence of a contract term, on reasonable notice to Retail Customer.

6.1.2.2.5 TEMPORARY DELIVERY SYSTEM FACILITIES

If, in the judgment of the Company, a proposed extension of the Company's Delivery System appears to be of a temporary nature, the Company shall require a non-refundable CIAC to be paid prior to the construction of the temporary facilities. The amount of the CIAC will be equal to the cost of installing and removing the temporary facilities, plus the estimated costs of materials to be used which are unsalvageable after removal of the installation.

6.1.2.2.6 REMOVAL AND RELOCATION OF COMPANY'S FACILITIES

The company may remove or relocate Company facilities upon request. If the removal or relocation of the Company facilities is associated with a change in the Retail Customer's requirements that results in additional load to the Company, then the appropriate Standard Allowance will be applied to the costs of removal or relocation. In

**TEXAS-NEW MEXICO POWER COMPANY
TARIFF FOR RETAIL DELIVERY SERVICE**

6.1. Rate Schedules

Applicable: Entire Certified Service Area

Effective Date: January 1, 2019

Page No. 156

Revision 11

all other cases, the requesting entity will pay the total cost of removing or relocating the facilities.

A. REPLACEMENT OF FACILITIES

1. If the Company, pursuant to Section 4, SERVICE RULES AND REGULATIONS RELATING TO ACCESS TO DELIVERY SYSTEM OF COMPANY BY COMPETITIVE RETAILERS, and Section 5, SERVICE RULES AND REGULATIONS RELATING TO THE PROVISION OF DELIVERY SERVICE TO RETAIL CUSTOMERS, replaces existing overhead facilities with underground facilities, the Retail Customer will pay the Company a non-refundable CIAC consisting of the cost of installing the underground facilities plus the cost of removal of any overhead facilities less any salvage value of the removed facilities.
2. If the Company, as a result of the legal requirement of a political subdivision of the State of Texas ("Political Subdivision"), replaces or redesigns existing overhead facilities with underground facilities, or if a Political Subdivision requests Non-Standard facilities, or requires any future electrical facilities to be installed underground, the Company may surcharge all Retail Customers within the Political Subdivision for the previously described cost involved in converting or redesigning overhead facilities to underground, or in Company fulfilling the request for Non-Standard facilities. If said Political Subdivision wishes to make other arrangements to reimburse the Company, such other arrangements as are acceptable to the Company shall be allowed as long as Retail Customers outside the Political Subdivision are not required to subsidize the cost of such replacement.
3. Retail Customers will be required to pay a non-refundable CIAC for any of the following:
 - a. Removal and/or relocation of facilities for aesthetic purposes;
 - b. Relocation of facilities due to modifications on customer's Premises such as, but not limited to, swimming pools, barns, sheds, fences, etc.;

**TEXAS-NEW MEXICO POWER COMPANY
TARIFF FOR RETAIL DELIVERY SERVICE****6.1. Rate Schedules****Applicable:** Entire Certified Service Area**Effective Date:** January 1, 2019**Page No. 157****Revision 11**

- c. Commercial developments requiring the relocation and/or removal of facilities not necessarily for the purpose of providing electric service for that commercial development.

B. CHANGES IN CUSTOMER FACILITIES

If a Retail Customer makes changes to its facilities which result in the Company being required to make changes to its system in order to either facilitate the changes or to bring the Company's facilities back into compliance with applicable Codes, or the Company's construction requirements, whichever is more stringent, the Retail Customer shall pay all costs incurred by the Company as the result of such changes.

6.1.2.2.7 TRANSMISSION LINE EXTENSIONS

Line extensions for transmission service customers shall be in accordance with Substantive Rules, §25.195 and §25.198, Terms and Conditions for Transmission Service. Transmission service customers shall provide ample notice to the Company for the purpose of filing Certificates of Convenience and Necessity and any other preparatory work in advance of construction.

A. STANDARD TRANSMISSION FACILITIES

Standard transmission facilities consist of the overhead Delivery System facilities necessary to transport Electric Power and Energy from a single transmission or transformation source to Retail Customer at one Point of Delivery via radial line, with one standard Company Meter, at one of the Company's available standard voltages. The Company will evaluate each new transmission service customer's request for connection to the transmission system to determine if a CIAC will be required. Additionally, the Company may require the transmission service customer to pay a deposit or provide other security to ensure costs for planning, licensing and constructing non-customer owned facilities are recoverable in the event the transmission service customer is unable to take transmission service.

**TEXAS-NEW MEXICO POWER COMPANY
TARIFF FOR RETAIL DELIVERY SERVICE**

6.1. Rate Schedules

Applicable: Entire Certified Service Area

Effective Date: January 1, 2019

Page No. 158

Revision 11

B. NON-STANDARD TRANSMISSION FACILITIES

Transmission service customers requesting non-standard facilities will be required to pay all costs associated with those facilities. This provision does not apply to facilities related to transmission constraints that the Electric Reliability Council of Texas has otherwise required the Company to construct.

LINE EXTENSION ALTERNATIVES

This document is published by the Public Utility Commission of Texas. Its purpose is to create an awareness of renewable energy technologies that may be viable alternatives to line extensions. Your utility company is required to distribute this document in accordance with the Commission's Substantive Rule 23.44(c)(3). Please note that the information provided here is to be used as a starting point only. You need to seriously evaluate available options before deciding which energy source is best suited for your particular situation.

SHOULD YOU CONSIDER RENEWABLE RESOURCES?

The economic decision to choose either a power line extension, solar power, or wind power requires careful analysis, just like any other investment. A line extension may include a one-time major expense, plus monthly bills. A solar or wind system will include a one-time major expense and will require a replacement of storage batteries every three to ten years, plus maintenance during the life of the system. Depending on your electricity needs, there may be additional costs for a backup generator, which include fuel and maintenance.

Stand-alone solar or wind systems are not normally used for water heating, space heating, refrigerated air conditioning, or electric cook stoves or ovens. These heating and cooling applications require more energy than what a stand-alone renewable system can economically provide. If your use of electricity includes such applications, the renewable system will need supplemental power from conventional energy sources.

Description of Solar and Wind Systems

Small-scale solar systems use photovoltaic (PV) cells to convert energy from sunlight. The basic principle of the energy conversion is the same as what takes place in a solar-powered calculator. A PV system can furnish electricity for communication systems, lights,

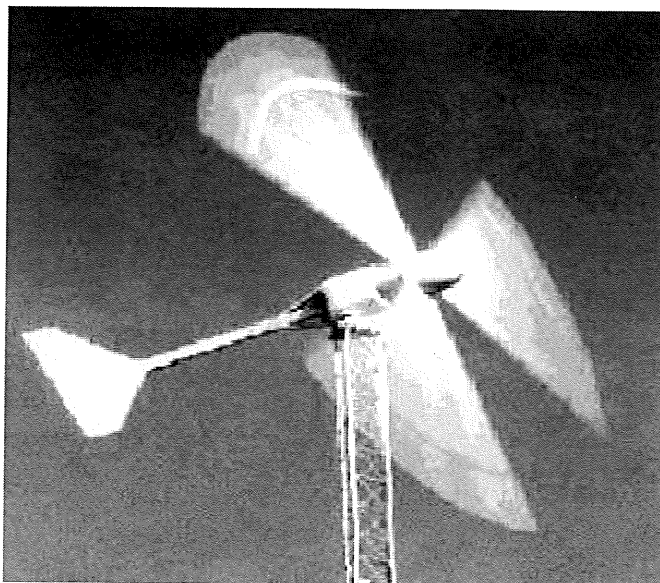

*Small Wind Turbine in Operation
(Courtesy of National Renewable Energy Laboratory)*

Customer Cost Considerations

<u>Line Extension</u>	<u>Solar or Wind</u>
line installation	initial system
utility bills	battery*
	maintenance
	backup generator*
	generator fuel*

*May be required.

Some Common Applications of Solar and Wind Power

water pumping	billboard lighting
microwave repeater	traffic control devices
beacons	recreational/security lighting
obstruction lighting	gate openers
remote residence	control and monitors

irrigation, and many other electric appliances. In the picture to the left, an outdoor light is powered by a PV system that is supplemented by a battery. During the daytime, when the light is not needed, energy from sunlight is used to charge the battery. At night, the light draws power from the battery.

Unlike the water-pumping "windmills" that are a common sight on Texas farms and ranches, modern wind energy generators -- or wind turbines -- produce electricity from the wind. As shown in the picture above, the wind pushes the turbine blades and turns the electric generator. The electricity that is produced when the wind is blowing can, as with PV, be used for a variety of purposes.

SYSTEM DESIGN

Designing a reliable, safe, cost-effective stand-alone renewable system requires knowledge of electrical usage characteristics, system components and system characteristics, local ambient temperature, sunlight intensity or wind speed data, electrical wiring practices, and electric codes. For example, sensitive electronic equipment such as personal computers may require a power conditioner to prevent damage to the equipment from an unsteady power supply. If you are inexperienced in these areas, you should get assistance from an expert who can advise you or provide you with the design and installation of

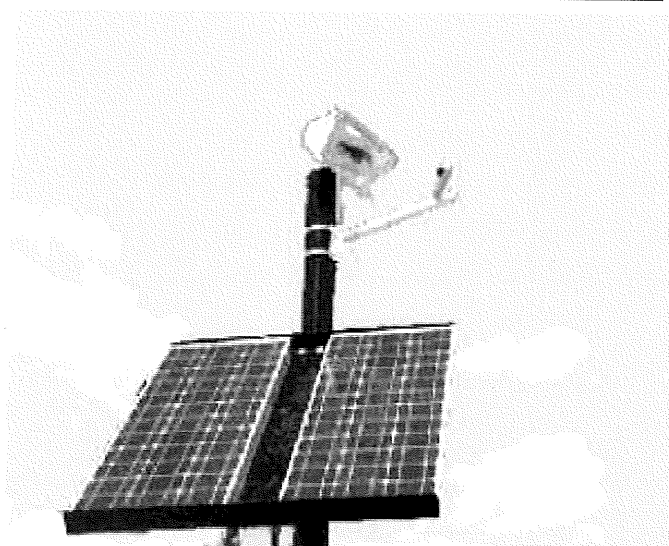

*PV-Powered Outdoor Light
(Courtesy of National Renewable Energy Laboratory)*

your system.

A computer program is often used in the system design process to size components, predict system performance, and produce cost estimates. Some Texas companies provide design services at little or no cost. The following steps briefly explain the design process and will help prepare you for discussing with prospective suppliers.

Step 1. Identify Electrical Loads

What equipment do you want to power with electricity? The answer to this question will determine the load that must be serviced by your PV or wind system. It may be a single-purpose system or you may be planning to operate a variety of appliances. This question must be answered completely to properly design your system.

The more power the equipment needs, the higher the system costs. Energy conservation and efficient equipment are essential to keep the system costs down.

Step 2. Identify Load Wattage

Once you have identified the individual electrical loads, you can determine the wattage¹ of each item. The wattage of a device is usually stamped or printed on a nameplate or identification plate on the unit.

Step 3. Estimate Electricity Use

You should estimate the number of hours you plan to use the equipment as precisely as possible. The number of hours of operation each day times the wattage determines the number of watt-hours your system will need to produce daily. If you plan to power more than one piece of equipment, you will need to know whether you will be using more than one at the same time.

Step 4. Estimate System Cost

A PV or wind dealer can estimate the cost of a system to meet your needs. In some instances, packaged systems for remote uses may be available from home improvement stores, hardware stores, or catalogs.

Availability of Electricity

A renewable system can produce electric power only when there is adequate wind or sunlight. Therefore, it is possible that electricity will not always be available at the moment when you need it. If uninterrupted power is important, you should consider a backup generator or a battery that can provide needed power when the renewable power is not available.

Safety Issues

General Guidelines for safe installation and maintenance include:

- compliance with the National Electrical Code and other applicable local code
- proper size of electrical conductors or wires
- appropriate fuses, circuit-breakers, and circuit disconnects
- proper grounding techniques
- elimination of exposed wires and connections
- adequate ventilation for battery gas
- safe disposal of batteries.

A properly designed and installed renewable system should be

¹ While mechanical power is measured in horsepower, the electrical power is measured in watt (w). Another familiar term for electrical power is kilowatt, which is equal to 1,000 w. One horsepower is equivalent to 746 watts.

able to provide many years of safe and reliable service.

More information about the PV design process can be found in the *Stand-Alone System Design Handbook*, available from Sandia National Laboratories, (505) 844-3698.

COMPANIES THAT PROVIDE PRODUCTS AND SERVICES

PV and wind systems are available from contractors and dealers. These contractors can assist you in deciding whether a PV or wind system is the best option for you. Your electric utility may offer this service.

This is potentially a big investment. Be sure to consult with more than one contractor. When you talk to your contractor, be sure to ask about the reliability of the system being proposed and the percent of time the system will provide the power you need. Get any warranties or guarantees in writing.

You may want to use the following questions as a starting point for talking with the contractors and dealers:

- Will a licensed electrician install the system?
- Is the contractor a member of any trade associations?
- Is there a written contract agreement and written system specifications?
- How long has the contractor been in business?
- What are the warranties on the system?
- Is the equipment UL-approved² or equivalent?
- Does the contractor provide service and maintenance for the system?

Use your judgment when dealing with contractors. Be sure to ask for references and check with your Better Business Bureau and the Texas Renewable Energy Industries Association for additional information on a particular contractor.

For your convenience, the Commission maintains a list of companies in Texas that provide renewable systems and services. To obtain a copy of the list please call the Commission's Central Records at (512) 936-7176 or download it from the Commission's web site at www.puc.state.tx.us.

This document is distributed in accordance with the requirement in Substantive Rule 23.44(c)(3) of the Public Utility Commission of Texas which states: "...the utility shall provide the customer with information about on-site renewable energy technology alternatives."

The information provided here is for educational purpose only and does not represent an endorsement of any particular option. The economic feasibility of alternatives has to be evaluated on a case by case basis. You need to conduct an additional investigation before making any decision on your investment

² UL stands for Underwriters Laboratories, an independent entity that conducts tests on devices, systems, and materials for their safety.